

Fast Ethernet and Gigabit Ethernet

Fast Ethernet (100BASE-T)

How to achieve 100 Mbps capacity?

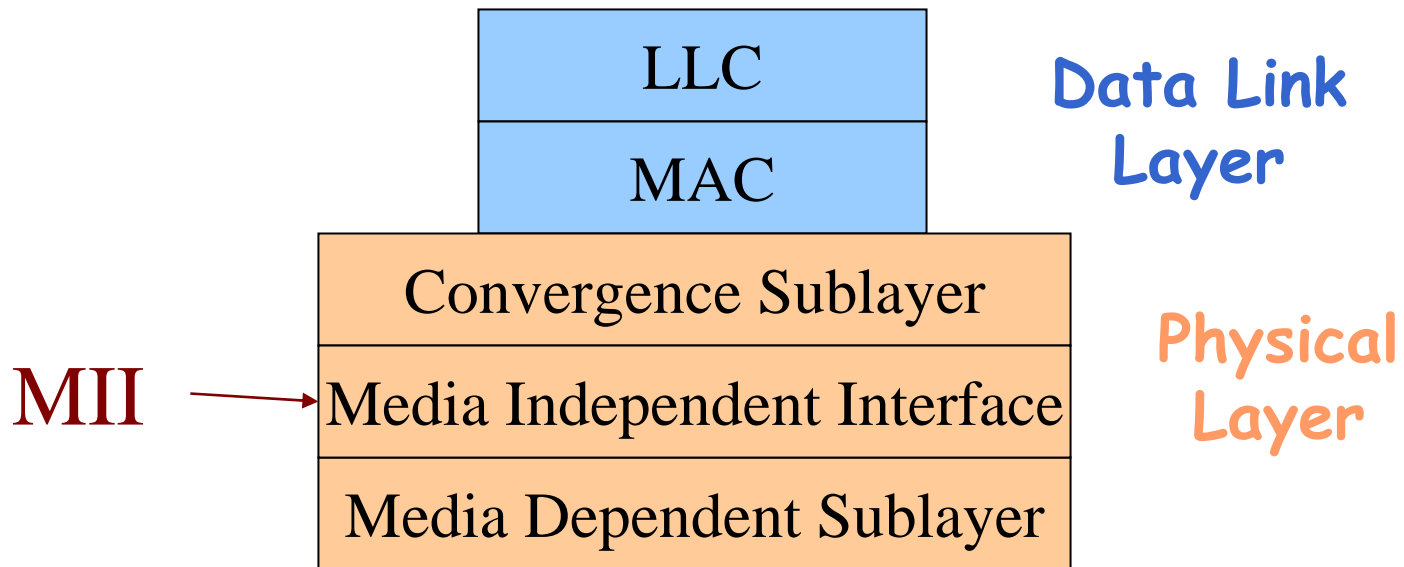

Media Independent Interface provides three choices.

Fast Ethernet [IEEE 802.3u]

Three Choices

Name	Cable	Max. segment	Advantages
100Base-T4	Twisted pair	100 m	Uses category 3 UTP
100Base-TX	Twisted pair	100 m	Full duplex at 100 Mbps
100Base-FX	Fiber optics	2000 m	Full duplex at 100 Mbps; long runs

Figure 4-21. The original fast Ethernet cabling.

*** Concept facilitated by 10Mbps/100Mbps Adapter Cards**

100 BASE T

Table 7.3 IEEE 802.3 100BASE-T Physical Layer Medium Alternatives

	100BASE-TX	100BASE-FX	100BASE-T4	
Transmission medium	2 pair, STP	2 pair, Category 5 UTP	2 optical fibers	4 pair, Category 3, 4, or 5 UTP
Signaling technique	MLT-3	MLT-3	4B5B, NRZI	8B6T, NRZ
Data rate	100 Mbps	100 Mbps	100 Mbps	100 Mbps
Maximum segment length	100 m	100 m	100 m	100 m
Network span	200 m	200 m	400 m	200 m

Fast Ethernet Details

- UTP Cable has a 30 MHz limit
 - ➔ **Not feasible to use clock encoding (i.e., NO Manchester encoding)**
- Instead use bit encoding schemes with sufficient transitions for receiver to maintain clock synchronization.

100 BASE T4

- Can use **four** separate twisted pairs of Cat 3 UTP
- Utilize three pair in both directions (at 33 1/3 Mbps) with other pair for carrier sense/collision detection.
- Three-level ternary code is used **8B/6T**.

Prior to transmission each set of 8 bits is converted into 6 ternary symbols.

100 BASE T4

- The signaling rate becomes

$$\frac{100 \times 6/8}{3} = 25 \text{ MHz}$$

- Three signal levels : +V, 0, -V
- Codewords are selected such that line is d.c. balanced.
- All codewords have a combined weight of 0 or 1.

100 BASE T4

- $3^6 = 729$ possible codewords.
- Only 256 codewords are required, hence they are selected:
 - To achieve d.c. balance
 - Assuming all codewords have at least two signal transitions within them (**for receiver clock synchronization**).
- To solve d.c. wander, whenever a string of codewords with +1 are sent, alternate codewords (**inverted before transmission**) are used.
- To reduce latency, ternary symbols are sent staggered on the three lines.

100 BASE T4

- **Ethernet** Interframe gap of 9.6 microseconds becomes 960 nanoseconds in **Fast Ethernet**.
- 100 m. max distance to hub; 200 meters between stations.
- Maximum of two Class II repeaters.

100 Base TX

- Uses two pair of twisted pair, one pair for transmission and one pair for reception.
- Uses either STP or Cat 5 UTP.
- Uses MTL-3 signaling scheme that involves three voltages.
- Uses 4B/5B encoding.
- There is a guaranteed signal transition at least every two bits.

100 BASE FX

- Uses two optical fibers, one for transmission and one for reception.
- Uses FDDI technology of converting 4B/5B to NRZI code group streams into optical signals.

Fast Ethernet Repeaters and Switches

- Class I Repeater – supports **unlike** physical media segments (*only one per collision domain*)
- Class II Repeater – limited to single physical media type (*there may be two repeaters per collision domain*)
- Switches – to improve performance can add **full-duplex** and have **autonegotiation** for speed mismatches.

Collision Domains

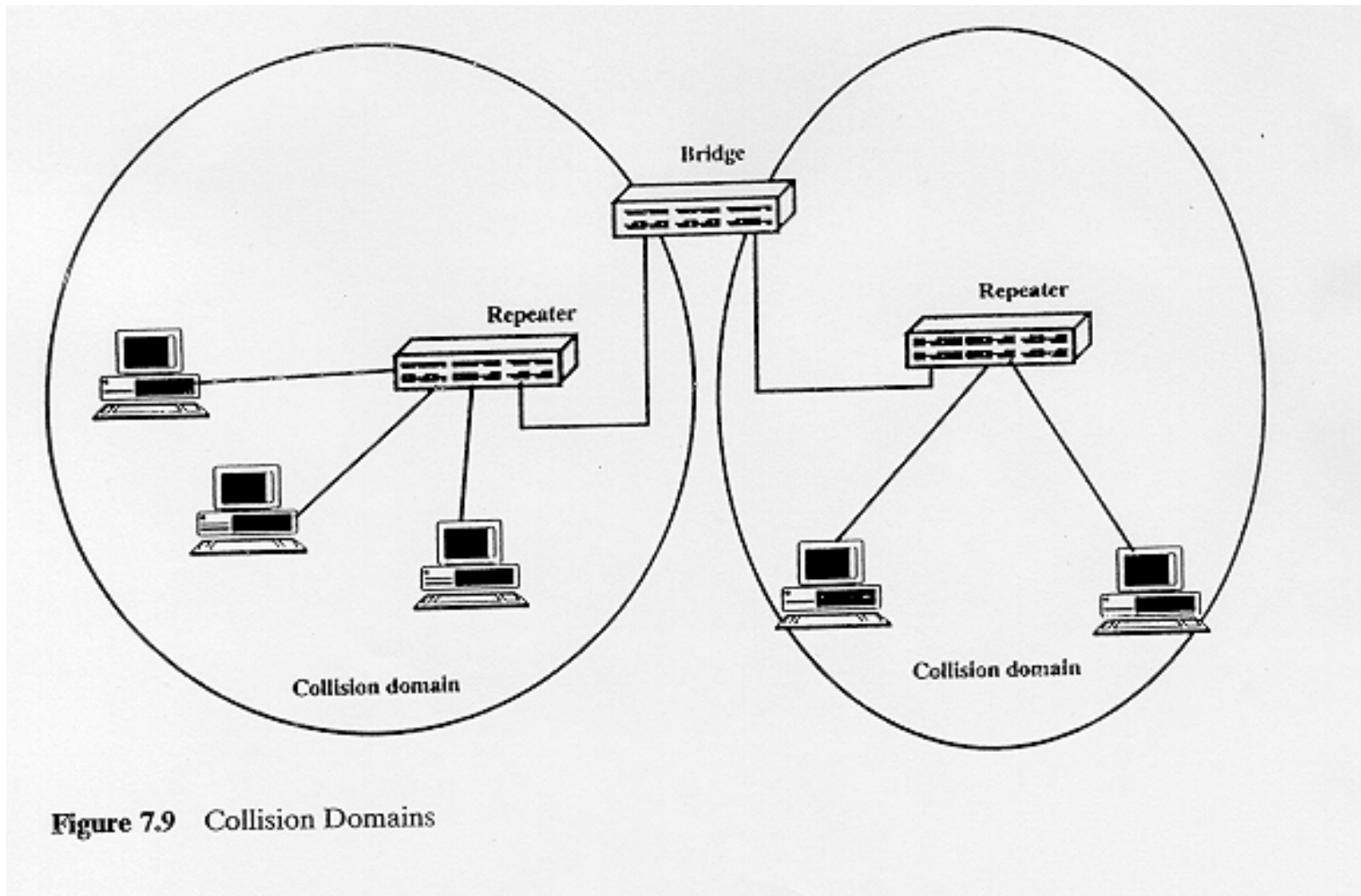

Figure 7.9 Collision Domains

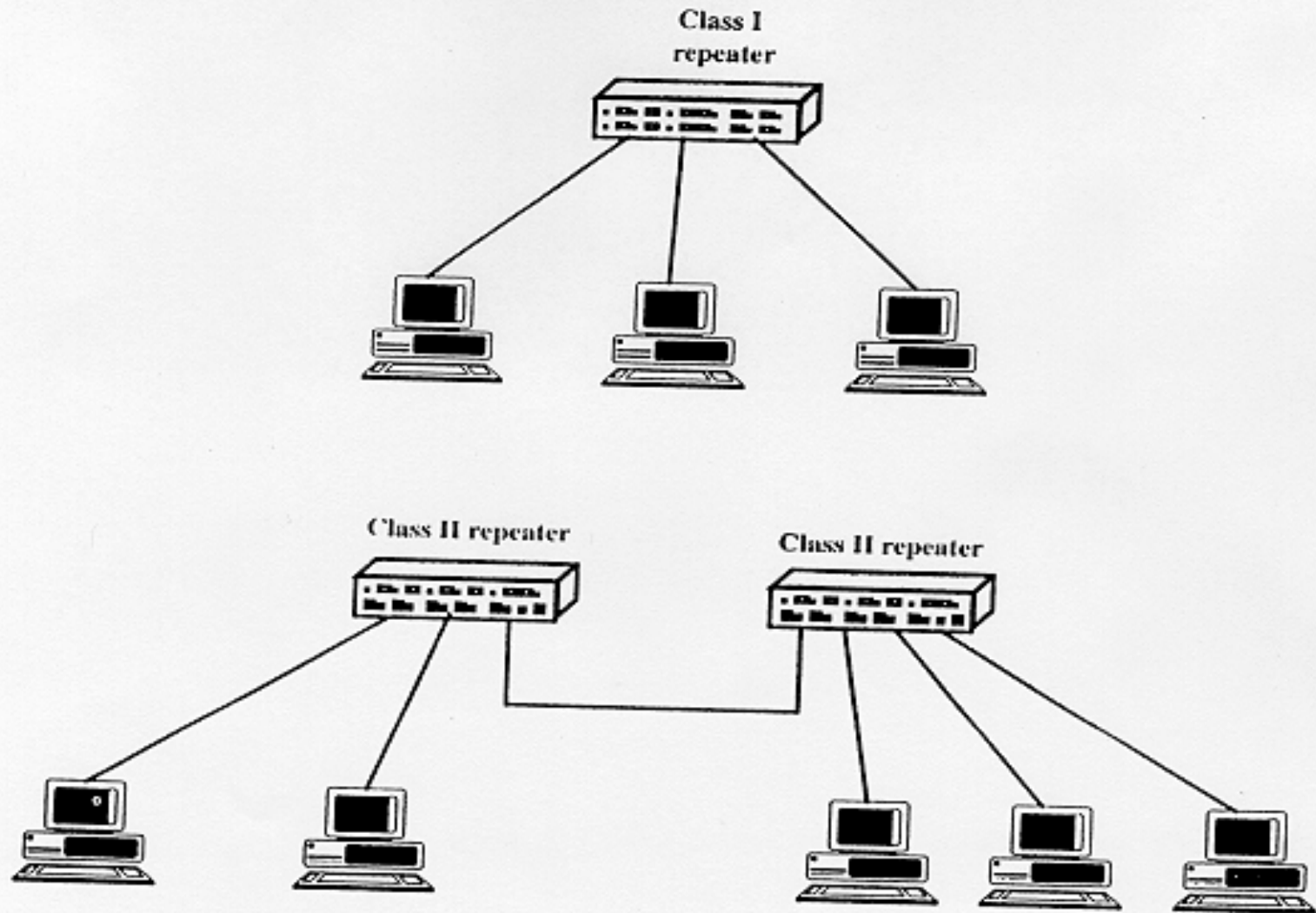

Figure 7.10 100BASE-T Repeater Types

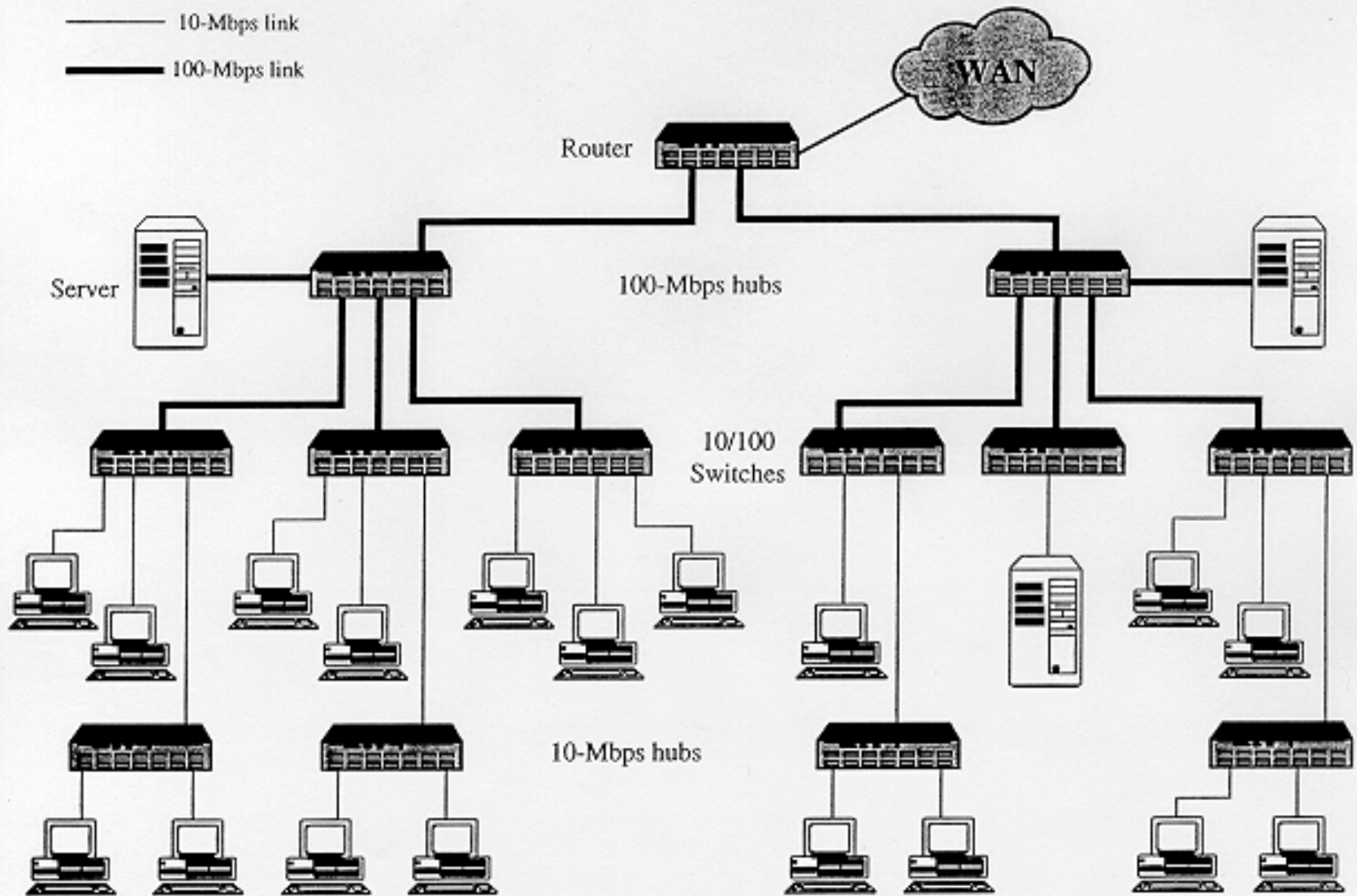

Figure 7.11 Example 100-Mbps Ethernet Backbone Strategy

Gigabit Ethernet History

- In February 1997 the **Gigabit Ethernet Alliance** announced that IEEE802.3z Task Force met to review the **first draft** of the Gigabit Ethernet Standard
- According to IDC by the end of 1997 **85%** of all network connections used **Ethernet**.
- ➔ Higher capacity Ethernet was appealing because network managers can leverage their investment in staff skills and training.
- **1000 BASE X (IEEE802.3z)** was ratified in June 1998.

Gigabit Ethernet (1000 BASE X)

- Provides speeds of 1000 Mbps (i.e., one billion bits per second capacity) for half-duplex and full-duplex operation.
- Uses Ethernet frame format and MAC technology
 - CSMA/CD access method with support for *one repeater per collision domain*.
 - Backward compatible with 10 BASE-T and 100 BASE-T.
- Uses 802.3 **full-duplex** Ethernet technology.
- Uses 802.3x *flow control*.
- All **Gigabit Ethernet** configurations are **point-to-point!**

Gigabit Ethernet Architecture Standard

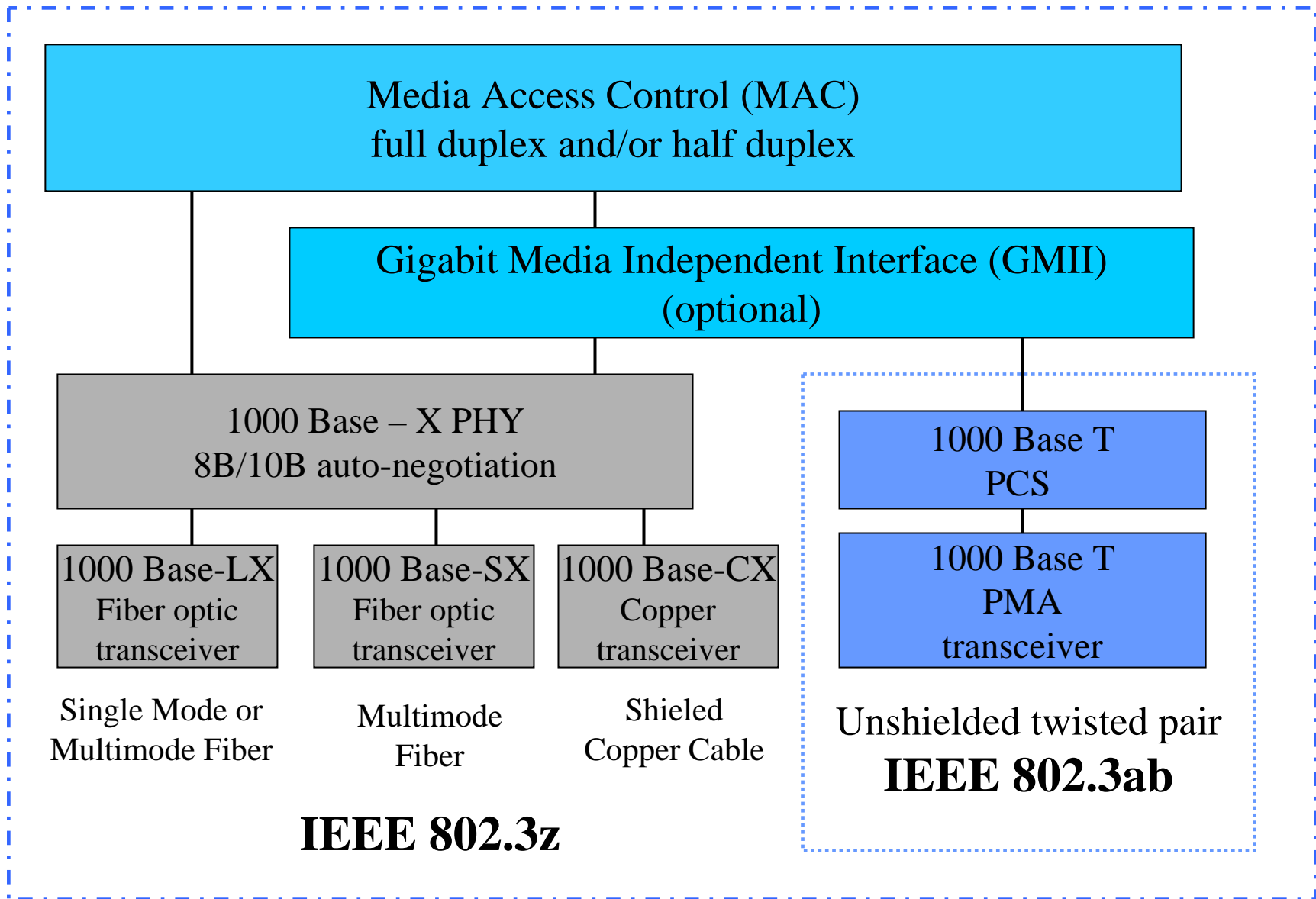

Gigabit Ethernet Technology

Name	Cable	Max. segment	Advantages
1000Base-SX	Fiber optics	550 m	Multimode fiber (50, 62.5 microns)
1000Base-LX	Fiber optics	5000 m	Single (10 μ) or multimode (50, 62.5 μ)
1000Base-CX	2 Pairs of STP	25 m	Shielded twisted pair
1000Base-T	4 Pairs of UTP	100 m	Standard category 5 UTP

Figure 4-23. Gigabit Ethernet cabling.

1000 BASE SX **fiber** - **short wavelength**
1000 BASE LX **fiber** - **long wavelength**
1000 BASE CX **copper** - **shielded twisted pair**
1000 BASE T **copper** - **unshielded twisted pair**

* Based on Fiber Channel physical signaling technology.

Gigabit Ethernet (1000 BASE-T)

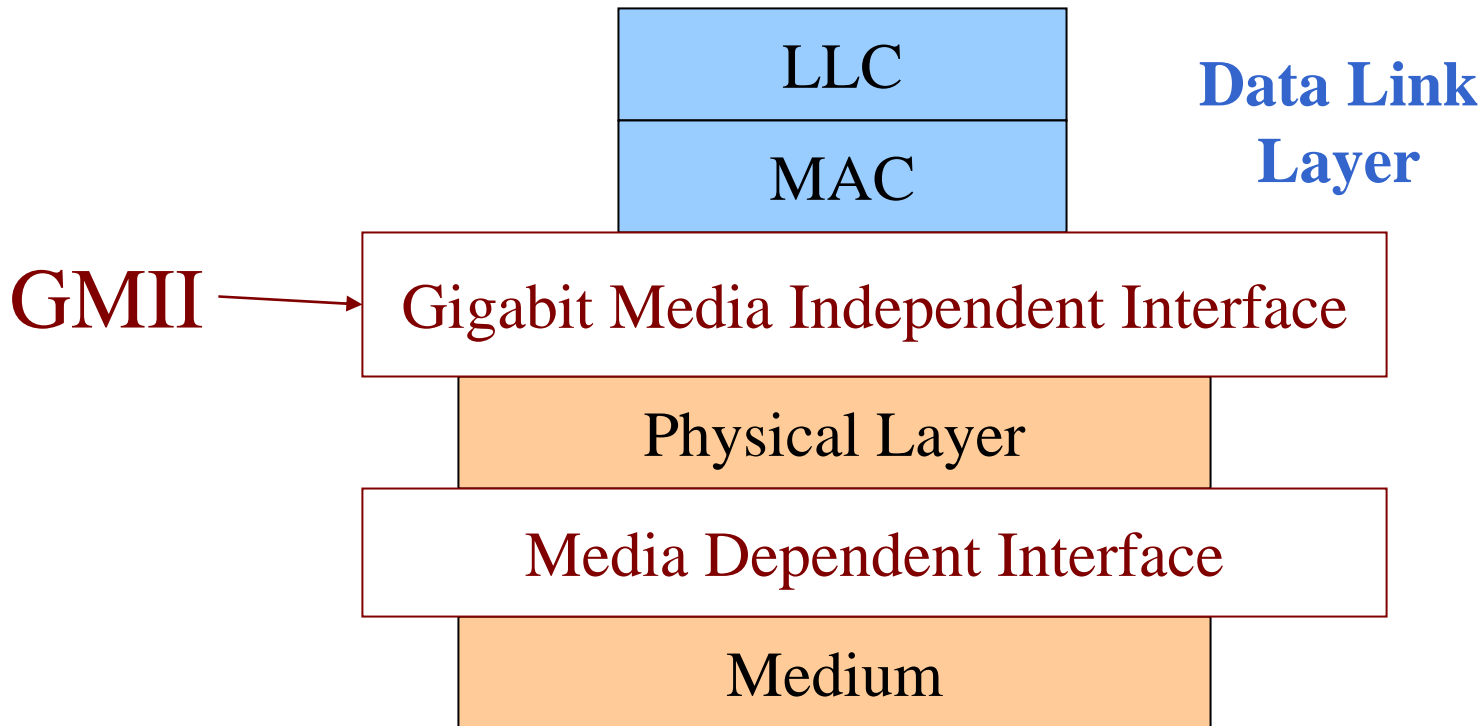

Gigabit Media Independent Interface (GMII)

- Allows any physical layer to be used with a given MAC.
- Namely, **Fiber Channel** physical layer can be used with CSMA/CD.
- Permits both full-duplex and half-duplex.

1000 BASE SX

Short wavelength

- Supports duplex links up to 275 meters.
- 770-860 nm range; **850 nm laser wavelength**
- **(FC) *Fiber Channel technology***
- **PCS (Physical Code Sublayer)** includes **8B/10B encoding** with 1.25 Gbps line.
- Only multimode fiber
- Cheaper than LX.

8B/10B Encoder

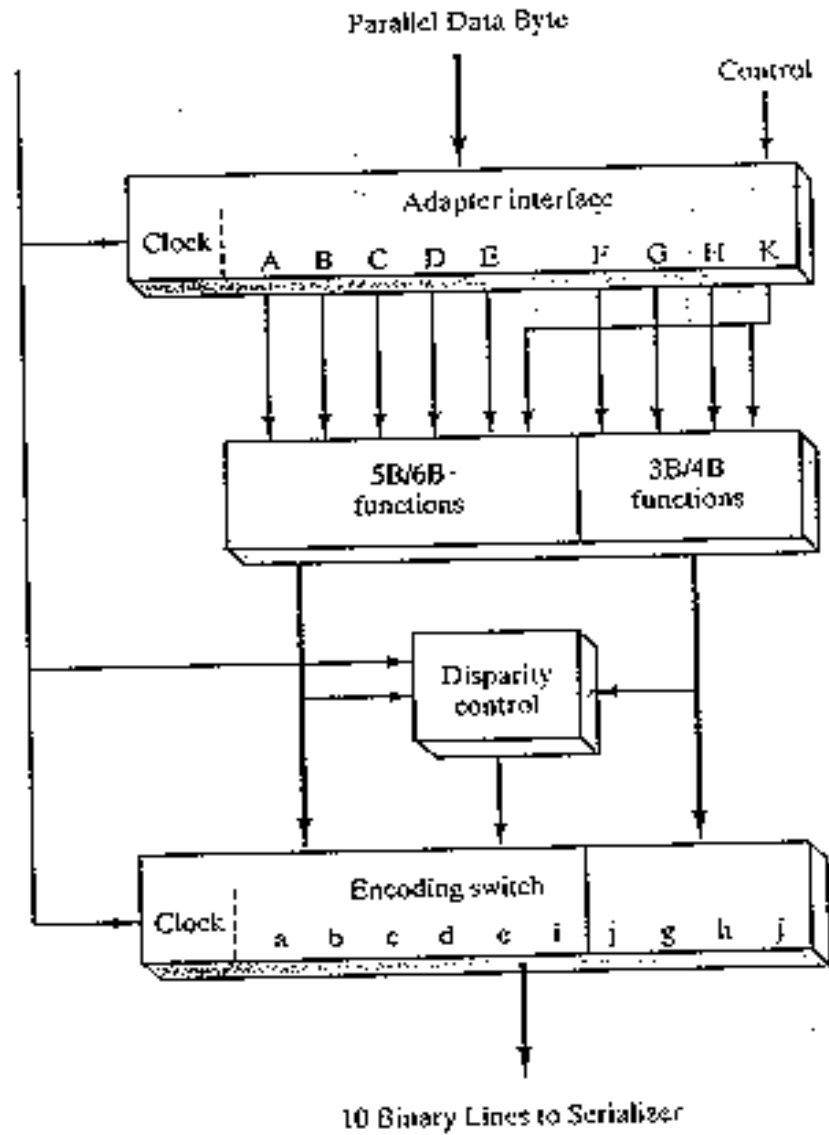

8B/10B Encoding Issues

EXAMPLES OF EIGHT-BIT CODE GROUPS

Code Group Name	Actual Byte Encoded	RD- Encoding Value	RD+ Encoding Value	Effect on RD after Sending
D1.0	000 00001	011101 0100	100010 1011	same
D4.1	001 00100	110101 1001	001010 1001	flip
D28.5	101 11100	001110 1010	001110 1010	same
O28.5	101 11100	001111 1010	110000 0101	flip

- When the encoder has a choice for codewords, it always chooses the codeword that moves in the direction of balancing the number of 0s and 1s. This keeps the DC component of the signal as low as possible.

1000 BASE LX

Long wavelength

- Supports duplex links up to 550 meters.
- 1270-1355 nm range; **1300 nm wavelength** using **lasers**.
- **Fiber Channel technology**
- **PCS (Physical Code Sublayer)** includes **8B/10B encoding** with 1.25 Gbps line.
- Either single mode or multimode fiber.

1000 BASE CX

'Short haul' copper jumpers

- Shielded twisted pair.
- 25 meters or less *typically within wiring closet.*
- **PCS (Physical Code Sublayer)** includes **8B/10B encoding** with 1.25 Gbps line.
- Each link is composed of a separate shielded twisted pair running in each direction.

1000 BASE T Twisted Pair

- **Four** pairs of Category 5 UTP.
- **IEEE 802.3ab ratified in June 1999.**
- Category 5, 6 and 7 copper up to 100 meters.
- This requires extensive signal processing.

Gigabit Ethernet compared to Fiber Channel

- Since **Fiber Channel (FC)** already existed, the idea was to *immediately* leverage physical layer of **FC** into **Gigabit Ethernet**.
- The difference is that fiber channel was viewed as *specialized* for high-speed I/O lines. **Gigabit Ethernet** is general purpose and can be used as a high-capacity switch.

Gigabit Ethernet

- Viewed as LAN solution while ATM is WAN solution.
- Gigabit Ethernet can be shared (hub) or switched.
- Shared Hub
 - Half duplex: CSMA/CD **with MAC changes:**
 - **Carrier Extension**
 - **Frame Bursting**
- Switch
 - Full duplex: Buffered repeater *called* **{Buffered Distributor}**

Gigabit Ethernet

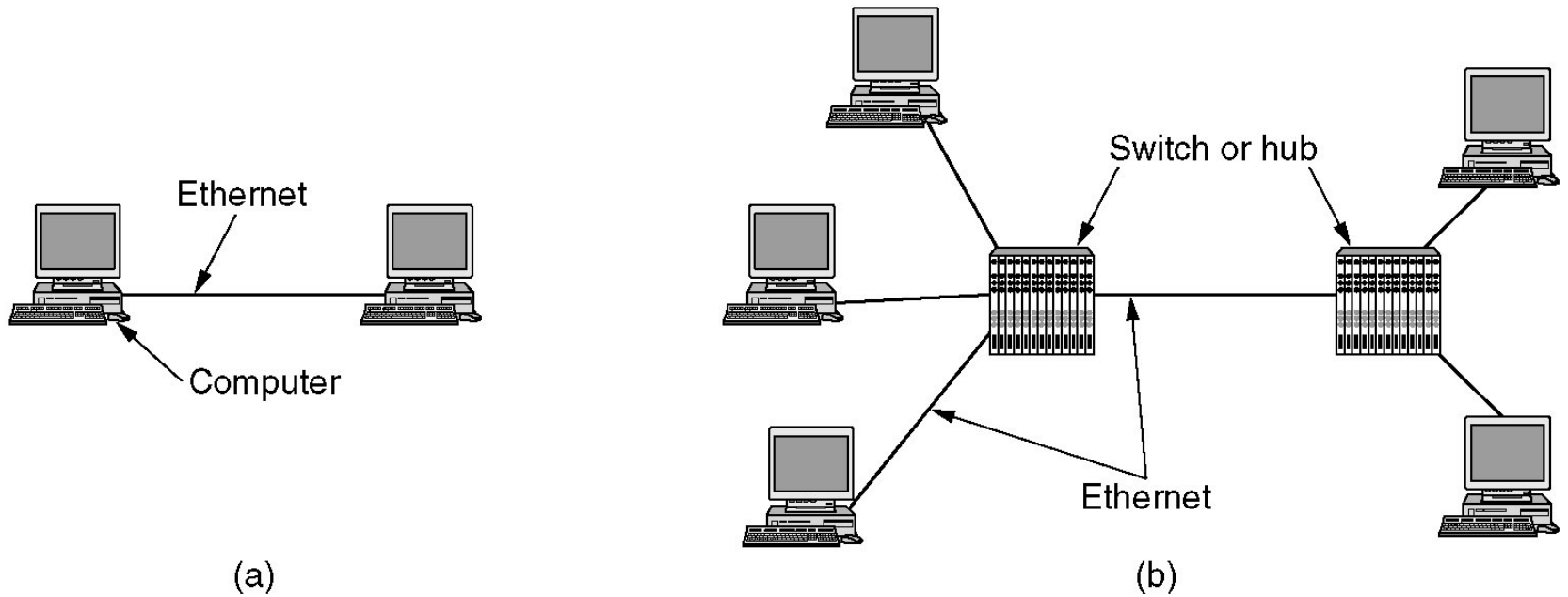
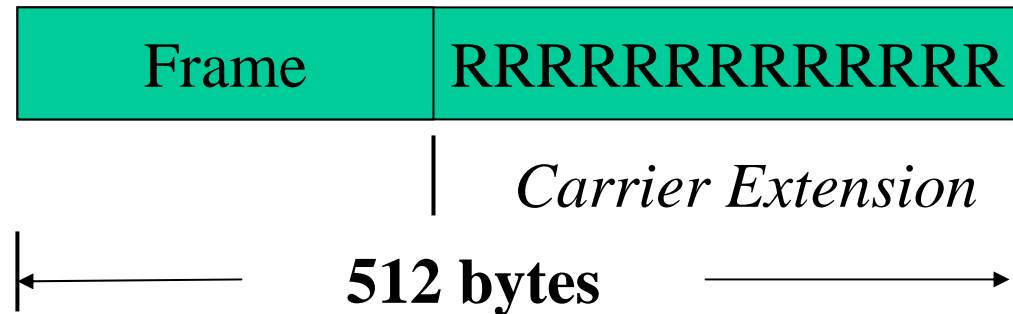

Figure 4-22. (a) A two-station Ethernet. (b) A multistation Ethernet.

Carrier Extension



- *For 10BaseT : 2.5 km max; slot time = 64 bytes*
- *For 1000BaseT: 200 m max; slot time = 512 bytes*
- **Carrier Extension** :: continue transmitting control
- *This permits minimum 64-byte frame to be handled.*
- Control characters discarded at destination.
- **For small frames, LAN throughput is only slightly better than Fast Ethernet.**

Frame Bursting

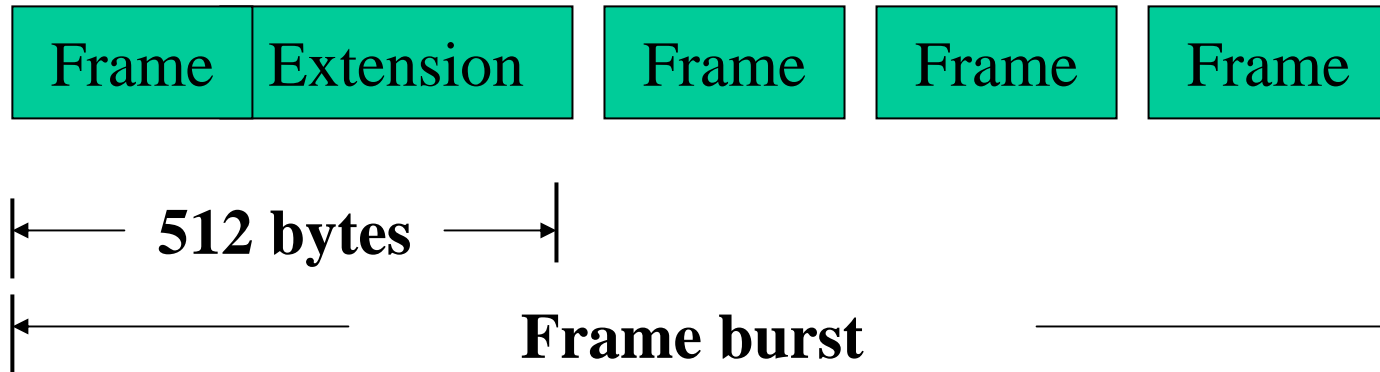

- Source sends out burst of frames without relinquishing control of the network.
- Uses Ethernet Interframe gap filled with extension bits (96 bits)
- Maximum frame burst is 8192 bytes
- **Three times more throughput for small frames.**

Buffered Distributor

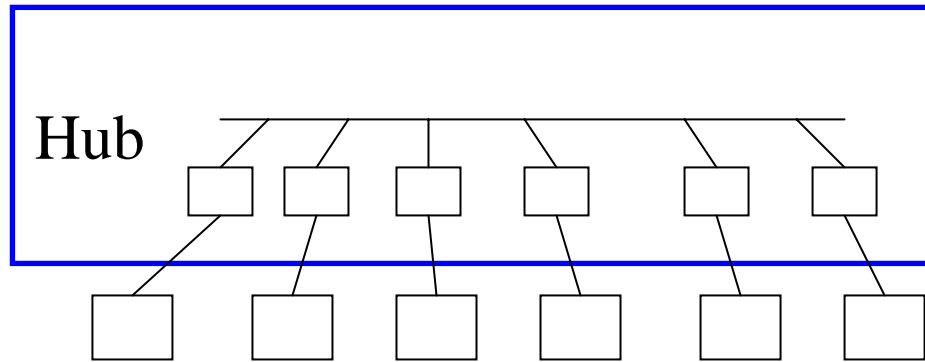

- A **buffered distributor** is a new type of 802.3 hub where incoming frames are buffered in FIFO queues.
 - Each port has an input FIFO queue and an output FIFO queue.
 - A frame arriving at an input queue is forwarded to all output queues, except the one on the incoming port.
- CSMA/CD arbitration is done **inside the distributor** to forward the frames to the output FIFOs.

Based on
Raj Jain slide and
Vijay Moorthy discussion

Buffered Distributor

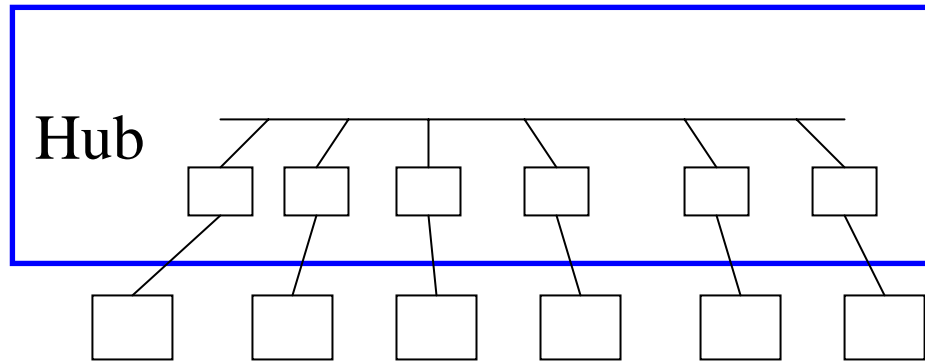

- Since collisions can no longer occur external to the distributor on the links, the distance restrictions no longer apply.
- Since the sender can flood an input FIFO, 802.3x frame-based flow control is used to handle congestion between the sending station and the input port.
- All links are full-duplex.

Based on
Raj Jain slide and
Vijay Moorthy discussion

Buffered Distributor

Buffered/Full duplex Distributor:

This is a multi-port repeater with full-duplex links.

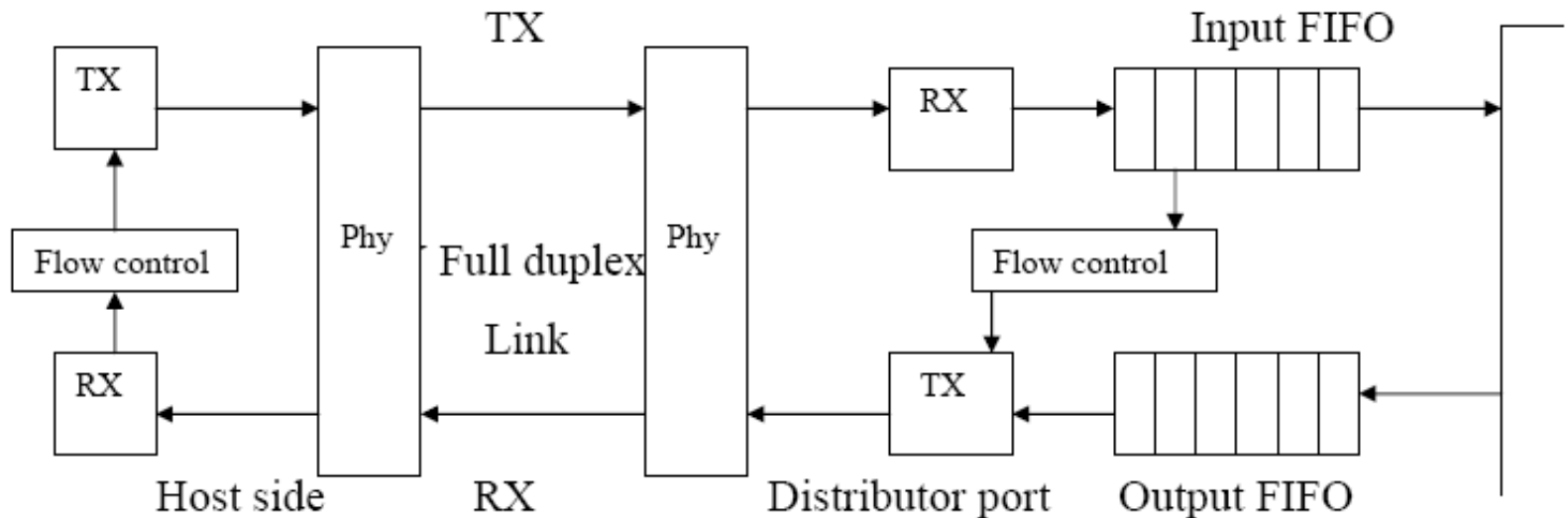

**White Paper
By
McIntyre and Arora**