

Physical Layer - Part 3

Transmission Media

Transmission Media

Transmission medium:: the physical path between transmitter and receiver.

- Repeaters or amplifiers may be used to extend the length of the medium.
- Communication of electromagnetic waves is *guided* or *unguided*.

Guided media :: waves are guided along a physical path (e.g, twisted pair, coaxial cable and optical fiber).

Unguided media:: means for transmitting but not guiding electromagnetic waves (e.g., the atmosphere and outer space).

Transmission Media Choices

- Twisted pair
- Coaxial cable
- Optical fiber
- Wireless communications

Digital Transmission Media Bit Rates

Digital transmission system	Bit rate	Observations
Telephone twisted pair	33.6 kbps	4 kHz telephone channel
Ethernet over twisted pair	10 Mbps	100 meters over unshielded twisted pair
Fast Ethernet over twisted pair	100 Mbps	100 meters using several arrangements of unshielded twisted pair
Cable modem	500 kbps to 4 Mbps	Shared CATV return channel
ADSL over twisted pair	64–640 kbps inbound 1.536–6.144 Mbps outbound	Uses higher frequency band and coexists with conventional analog telephone signal, which occupies 0–4 kHz band
Radio LAN in 2.4 GHz band	2 Mbps	IEEE 802.11 wireless LAN
Digital radio in 28 GHz band	1.5–45 Mbps	5 km multipoint radio link
Optical fiber transmission system	2.4–9.6 Gbps	Transmission using one wavelength
Optical fiber transmission system	1600 Gbps and higher	Multiple simultaneous wavelengths using wavelength division multiplexing

TABLE 3.3 Bit rates of digital transmission systems

Twisted Pair

- Two insulated wires arranged in a spiral pattern.
- Copper or steel coated with copper.
- The signal is transmitted through one wire and a ground reference is transmitted in the other wire.
- Typically twisted pair is installed in building telephone wiring.
- Local loop connection to central telephone exchange is twisted pair.

Twisted Pair

- Limited in distance, bandwidth and data rate due to problems with attenuation, interference and noise.
 - Issue: *cross-talk* due to interference from other signals.
 - “shielding” wire (shielded twisted pair (STP)) with metallic braid or sheathing reduces interference.
 - “twisting” reduces low-frequency interference and crosstalk.

Twisted Pair



(a)



(b)

Fig 2-3. (a) Category 3 UTP. (b) Category 5 UTP.

UTP (Unshielded Twisted Pair)

Category Specifications

EIA/TIA Category Specification provide for the following cable transmission speeds with specifications (Note prior to Jan94 UL and Anixter developed a LEVEL system which has been dropped or harmonized with the CATEGORY system);

Category 1 = No performance criteria

Category 2 = Rated to 1 MHz (used for telephone wiring)

Category 3 = Rated to 16 MHz (used for Ethernet 10Base-T)

Category 4 = Rated to 20 MHz (used for Token-Ring, 10Base-T)

Category 5 = Rated to 100 MHz (used for 100Base-T, 10Base-T)

UL LAN Cable Certification Program - Underwriters Laboratories
publication 200-120 30M/3/92, 1992 [characteristics of Cat 3-5 UTP]

Category 3 corresponds to ordinary voice-grade twisted pair found in abundance in most office buildings.

Category 5 (used for Fast Ethernet) is much more tightly twisted.

latest standards: <http://www.dslreports.com/faq/5010>

EIA/TIA 568 and ISO/IEC 11801 Wiring Grades

Grade 1 - Unshielded Untwisted wiring.

Commonly called inside wire by the Telco community.

Grade 2 - Unshielded twisted pair (UTP) derived from IBM Type 3 spec.

Category 3 - Unshielded twisted pair with 100 ohm impedance and electrical characteristics supporting transmission at frequencies up to **16 MHz**. May be used with 10Base-T, 100Base-T4, and 100Base-T2 Ethernet. **(Obsolete)**

Category 4 - Unshielded twisted pair with 100 ohm impedance and electrical characteristics supporting transmission at frequencies up to **20 MHz**. May be used with 10Base-T, 100Base-T4, and 100Base-T2 Ethernet. **(Obsolete)**

Category 5 - Unshielded twisted pair with 100 ohm impedance and electrical characteristics supporting transmission at frequencies up to **100 MHz**. May be used with 10Base-T, 100Base-T4, 100Base-T2, and 100Base-TX Ethernet. May support 1000Base-T, but cable should be tested. **(Superseded by Cat5e)**

EIA/TIA 568 and ISO/IEC 11801 Wiring Grades

Category 5e - "Enhanced Cat 5" exceeds Cat 5 performance. Very similar to Cat 5, it has improved specifications for NEXT (Near End Cross Talk), PSELFEXT (Power Sum Equal Level Far End Cross Talk), and Attenuation. May be used for 10Base-T, 100Base-T4, 100Base-T2, 100BaseTX and 1000Base-T Ethernet.
(Minimum acceptable wiring grade)

Category 6 - In June 2002 TIA approved specification for Cat 6 doubling Cat 5 bandwidth to **250 MHz**. Cat 6 is backward compatible with lower Category grades and supports the same Ethernet standards as Cat 5e. A Cat 6 whitepaper is available from TIA. Currently there are no Ethernet standards that take advantage of Cat 6. ANSI/TIA854 is working on 1000Base-TX. When complete this standard will use two pair in each direction as opposed to all four for 1000Base-T over Cat 5e. This is expected to reduce the cost of Gigabit Ethernet implementations. 1000Base-TX will only operate over Cat6.

Category 7 - Proposed standard to support transmission at frequencies up to **600 MHz** over 100 ohm twisted pair.

EIA/TIA 568 and ISO/IEC 11801 Wiring Grades

NOTES:

- 1) EIA 568 limits UTP copper cabling to maximum distance of **100 meters** (328 feet). 90 meters of cable plus 10 meters of patch cord split between both ends.
- 2) The FCC recently changed the requirement for telephone inside wiring to minimum of Cat 3 due to crosstalk problems with nontwisted quad-four. Cat 3 is no longer recognized by TIA. The minimum wiring grade for structured wiring is Cat 5e.
- 3) For installation to meet specific Category requirements all components must meet or exceed the designated Category. Using a Cat 3 receptacle (or patch cord) on Cat 6 reduces performance to Cat 3.

Digital Subscriber Line (DSL) [LG&W p.137]

*Telephone companies originally transmitted within the 0 to 4K HZ range to reduce crosstalk. **Loading coils** were added within the subscriber loop to provide a *flatter transfer function* to further improve voice transmission within the 3K HZ band while *increasing attenuation at the higher frequencies.**

ADSL (Asymmetric Digital Subscriber Line)

- Uses existing twisted pair lines to provide higher bit rates that are possible with *unloaded* twisted pairs (i.e., there are no **loading coils** on the subscriber loop.)

ADSL

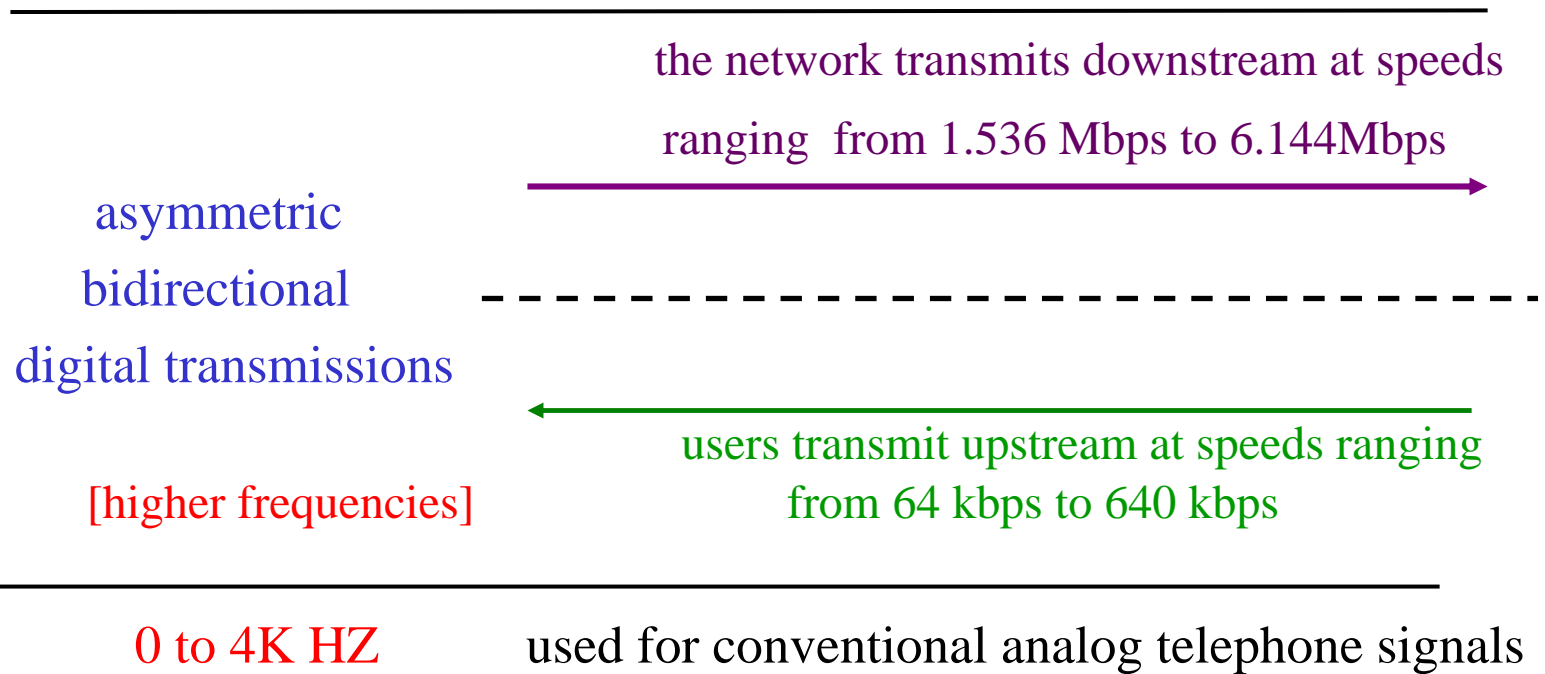

Digital Subscriber Lines

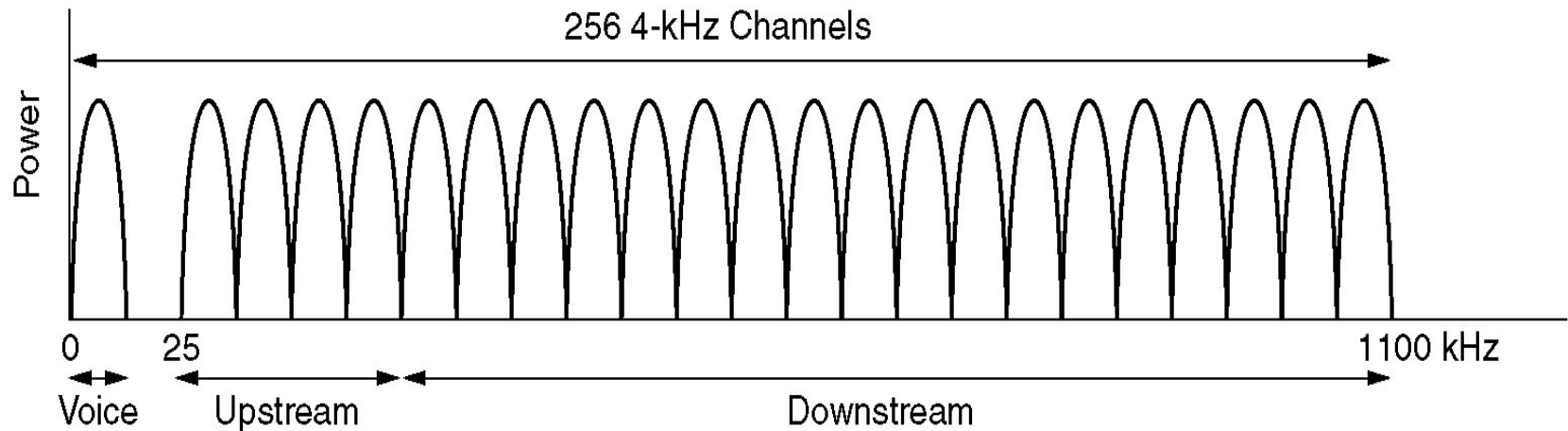

Figure 2-28. Operation of ADSL using discrete multitone modulation.

DSL

- ITU-T G992.1 ADSL standard uses Discrete Multitone (DMT) that divides the bandwidth into a large number of small subchannels.
- A *splitter* is required to separate voice signals from the data signal.
- The binary information is distributed among the subchannels. Each subchannel uses QAM.
- DMT adapts to line conditions by avoiding subchannels with poor SNR.

Digital Subscriber Lines

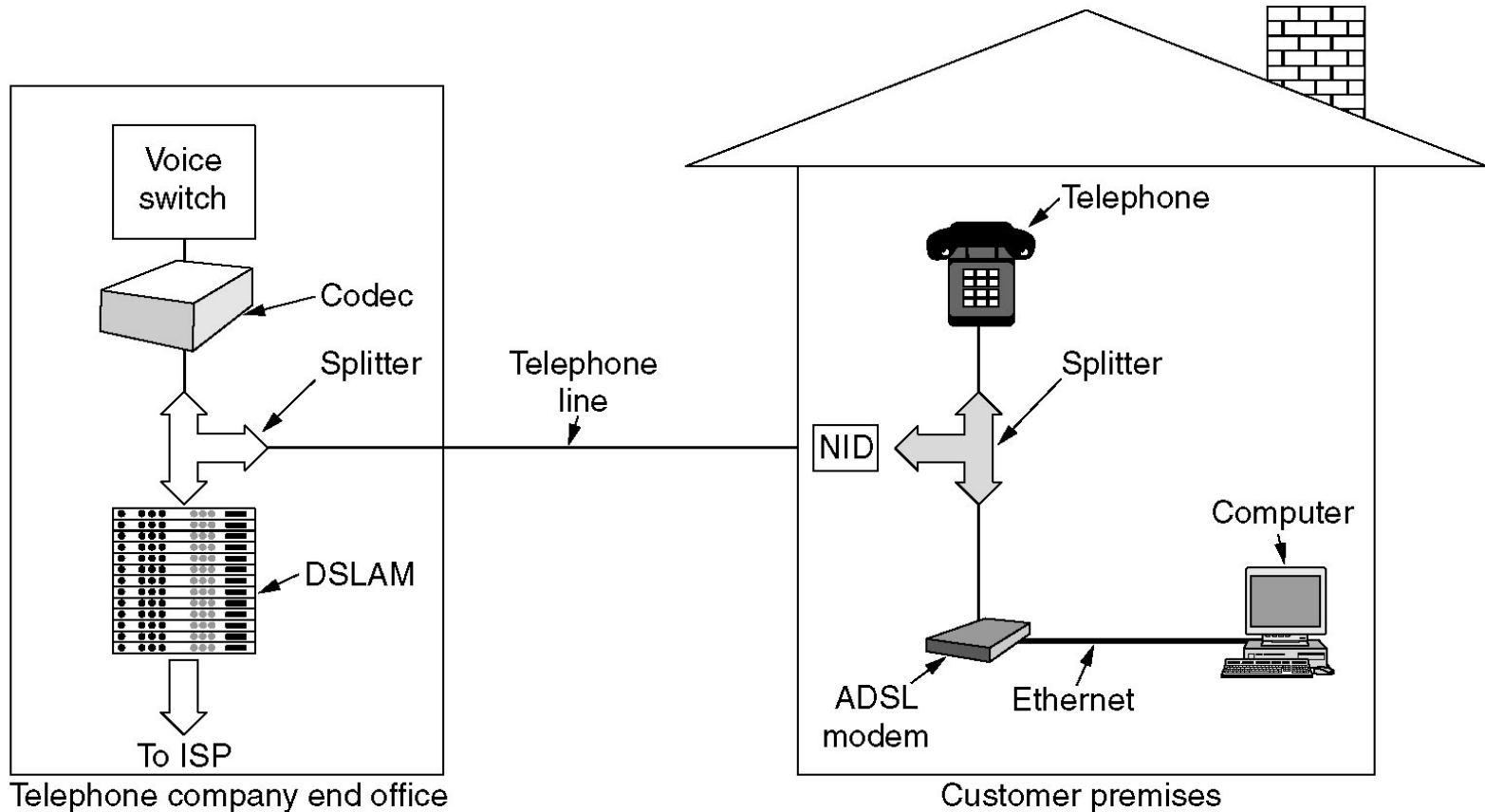
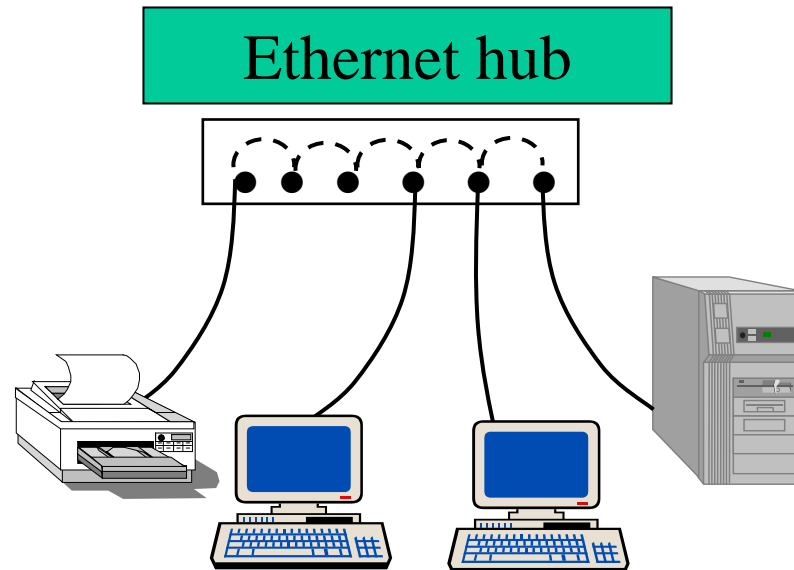

Figure 2-29. A typical ADSL equipment configuration.

10BASE-T

10 Mbps baseband transmission over *twisted pair*.
Two Cat 3 cables, Manchester encoding,
Maximum distance - 100 meters



Coaxial Cable

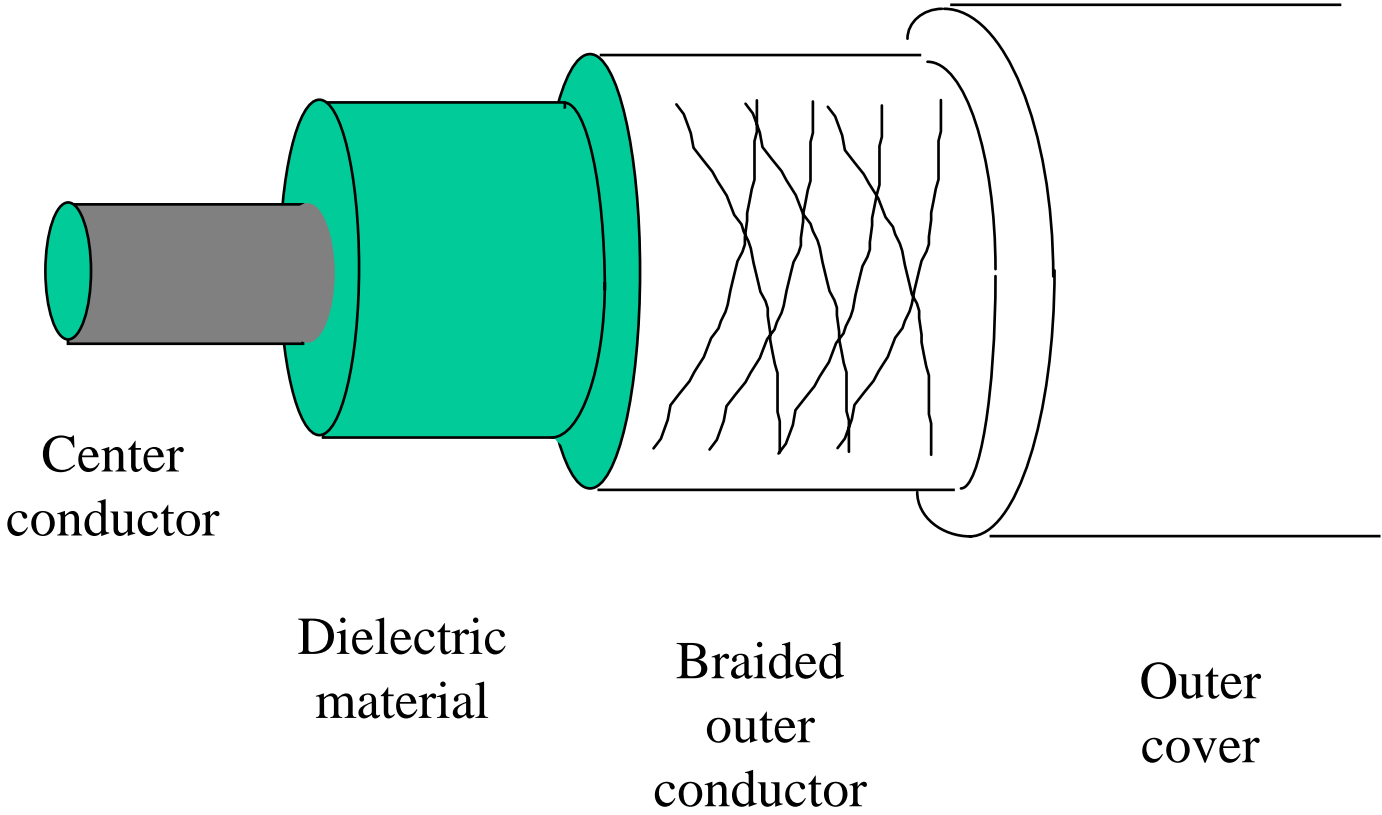

Coaxial Cable

- Discussion divided into two basic categories for coax used in LANs:
 - 50-ohm cable [**baseband**]
 - 75-ohm cable [**broadband or single channel baseband**]
- In general, coaxial cable has better noise immunity for higher frequencies than twisted pair.
- Coaxial cable provides much higher bandwidth than twisted pair.
- However, the cable is ‘bulky’.

Baseband Coax

- 50-ohm cable is used exclusively for digital transmissions.
- Uses Manchester encoding, geographical limit is a few kilometers.

10Base5 *Thick Ethernet* :: thick (10 mm) coax
10 Mbps, 500 m. max segment length, 100 devices/segment, awkward to handle and install.

10Base2 *Thin Ethernet* :: thin (5 mm) coax
10 Mbps, 185 m. max segment length, 30 devices/segment, easier to handle, uses T-shaped connectors.

Broadband Coax

- 75-ohm cable (CATV system standard).
- Used for both analog and digital signaling.
- Analog signaling – frequencies up to 500 MHz are possible.
- When FDM used, referred to as *broadband*.
- For long-distance transmission of analog signals, amplifiers are needed every few kilometers.

Hybrid Fiber-Coaxial System

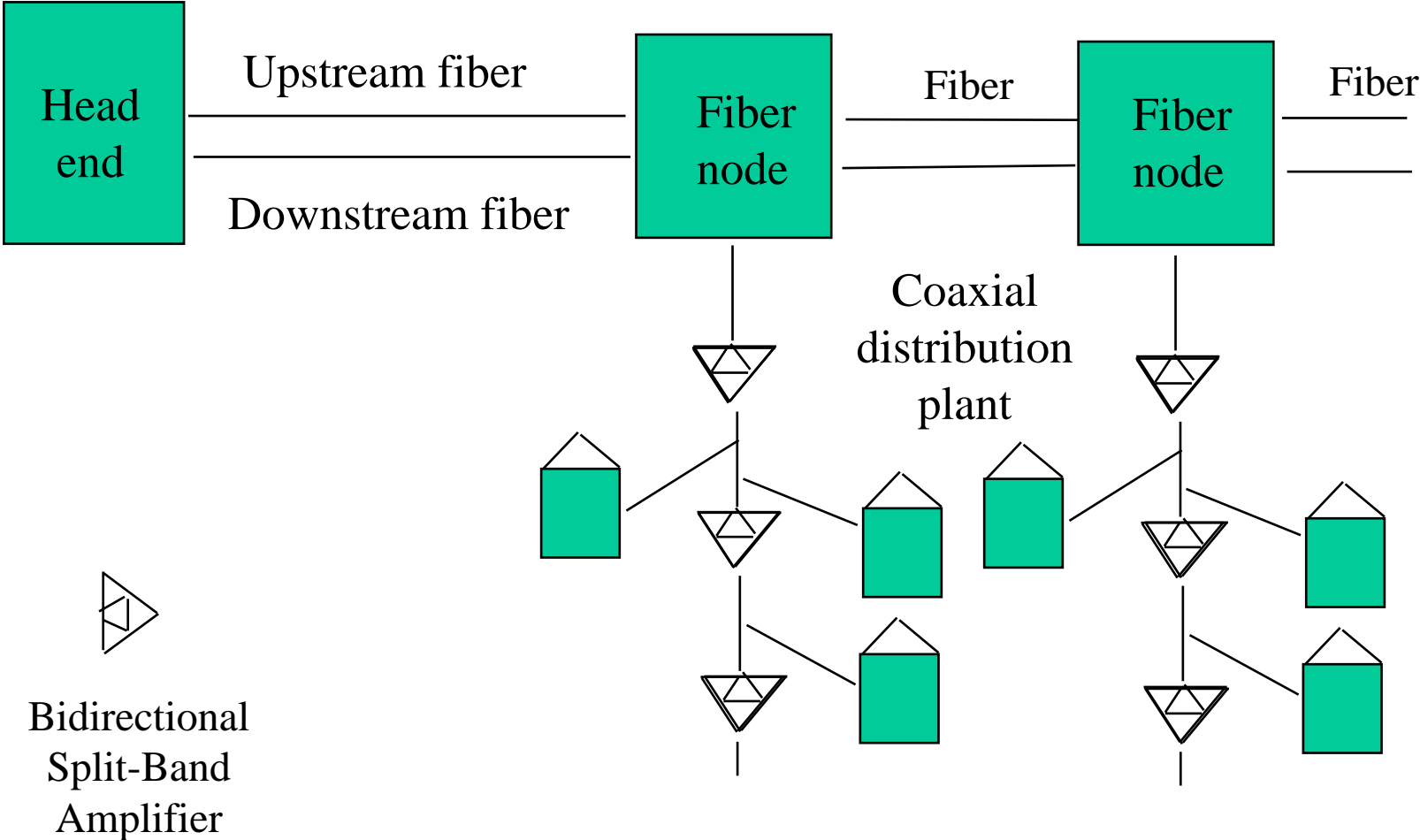

Optical Fiber

- Optical fiber :: a thin flexible medium capable of conducting optical rays. Optical fiber consists of a very fine cylinder of glass (core) surrounded by concentric layers of glass (cladding).
- a signal-encoded beam of light (a fluctuating beam) is transmitted by total internal reflection.
- Total internal reflection occurs in the core because it has a higher optical density (index of refraction) than the cladding.
- Attenuation in the fiber can be kept low by controlling the impurities in the glass.

Optical Fiber

(a) Geometry of optical fiber

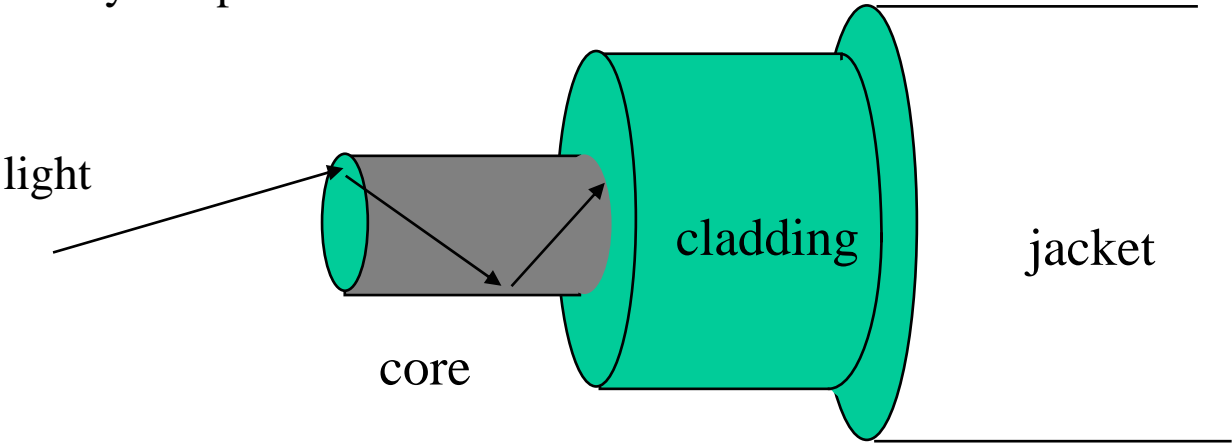

(b) Reflection in optical fiber

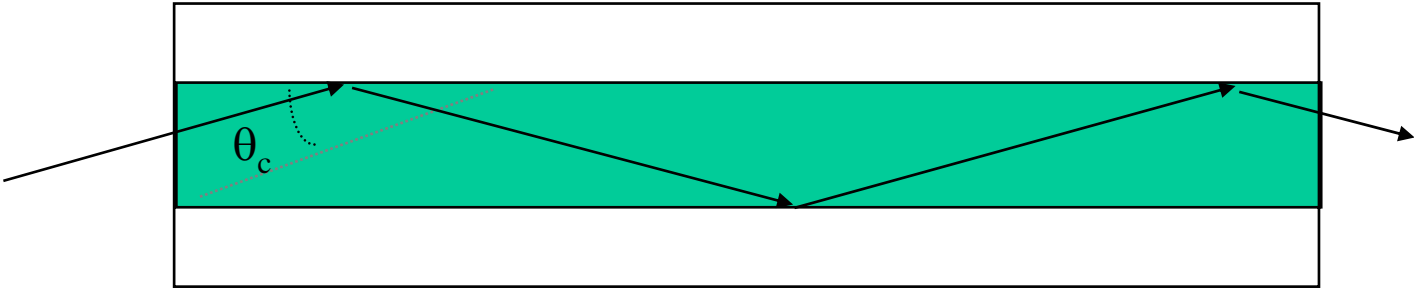

Optical Fiber

- Lowest signal losses are for ultrapure fused silica – **but this is hard to manufacture.**
- Optical fiber acts as a wavelength guide for frequencies in the range 10^{14} to 10^{15} HZ which covers the visible and part of the infrared spectrum.
- Three standard wavelengths : 850 nanometers (nm.), 1300 nm, 1500 nm.
- *First-generation optical fiber* :: 850 nm, 10's Mbps using LED (light-emitting diode) sources.
- *Second and third generation optical fiber* :: 1300 and 1500 nm using ILD (injection laser diode) sources, gigabits/sec.

Optical Fiber

- Attenuation loss is lower at higher wavelengths.
- There are two types of detectors used at the receiving end to convert light into electrical energy (photo diodes):
 - PIN detectors – less expensive, less sensitive
 - APD detectors
- ASK is commonly used to transmit digital data over optical fiber {referred to as *intensity modulation*}.

Optical Fiber

- Three techniques:
 - Multimode step-index
 - Multimode graded-index
 - Single-mode step-index
- Presence of multiple paths → differences in delay → optical rays *interfere* with each other.
- A **narrow core** can create a single direct path which yields higher speeds.
- WDM (Wavelength Division Multiplexing) yields more available capacity.

(a) Multimode fiber: multiple rays follow different paths

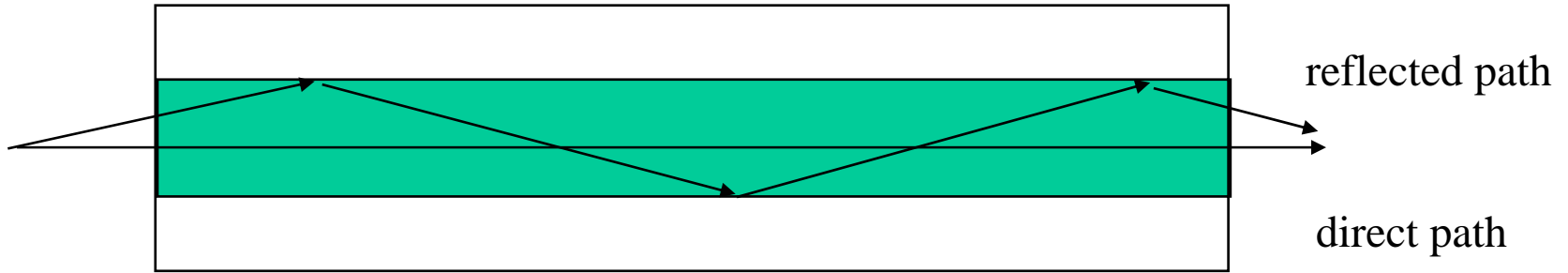

(b) Single mode: only direct path propagates in fiber



Electromagnetic Spectrum

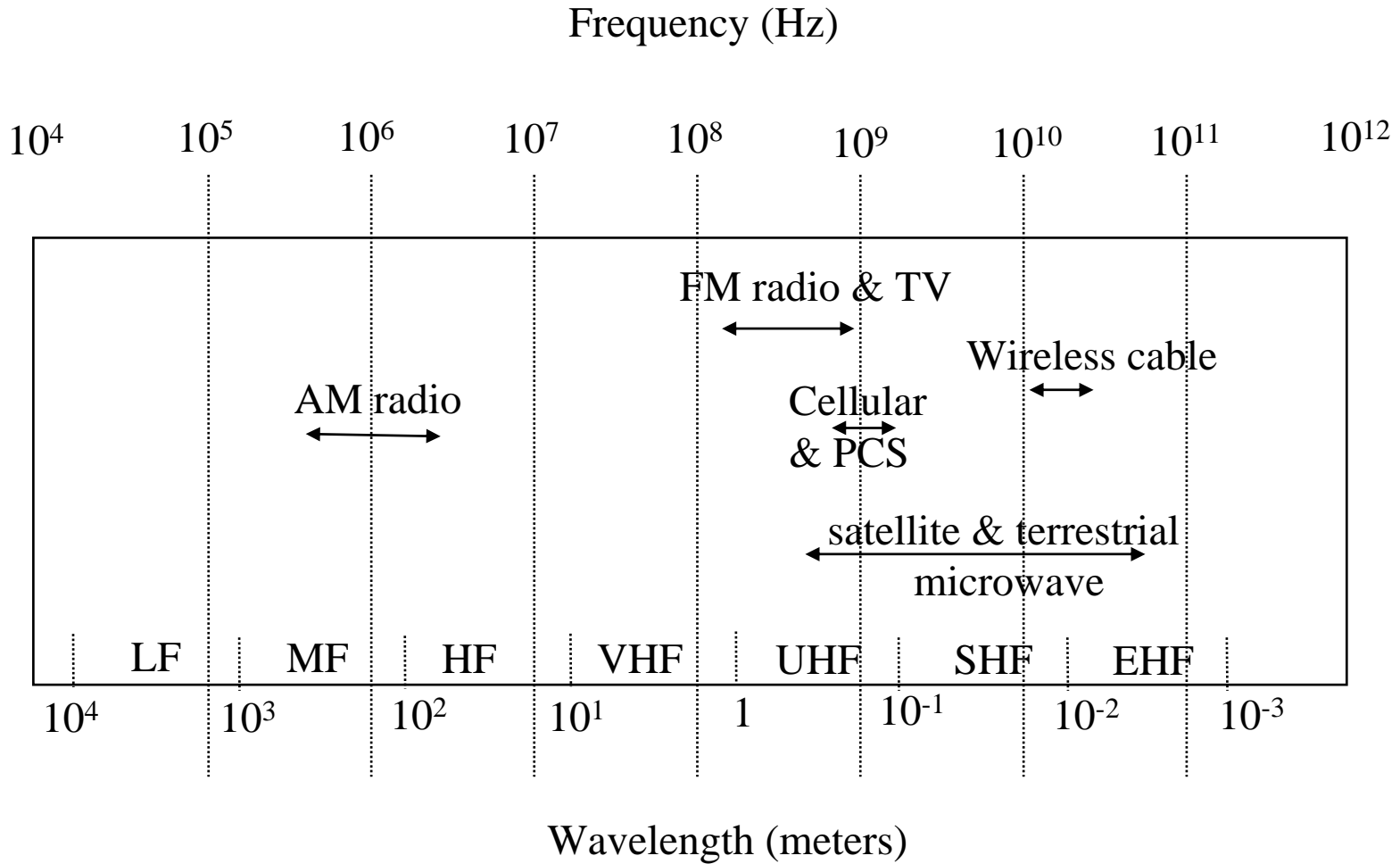

The Electromagnetic Spectrum

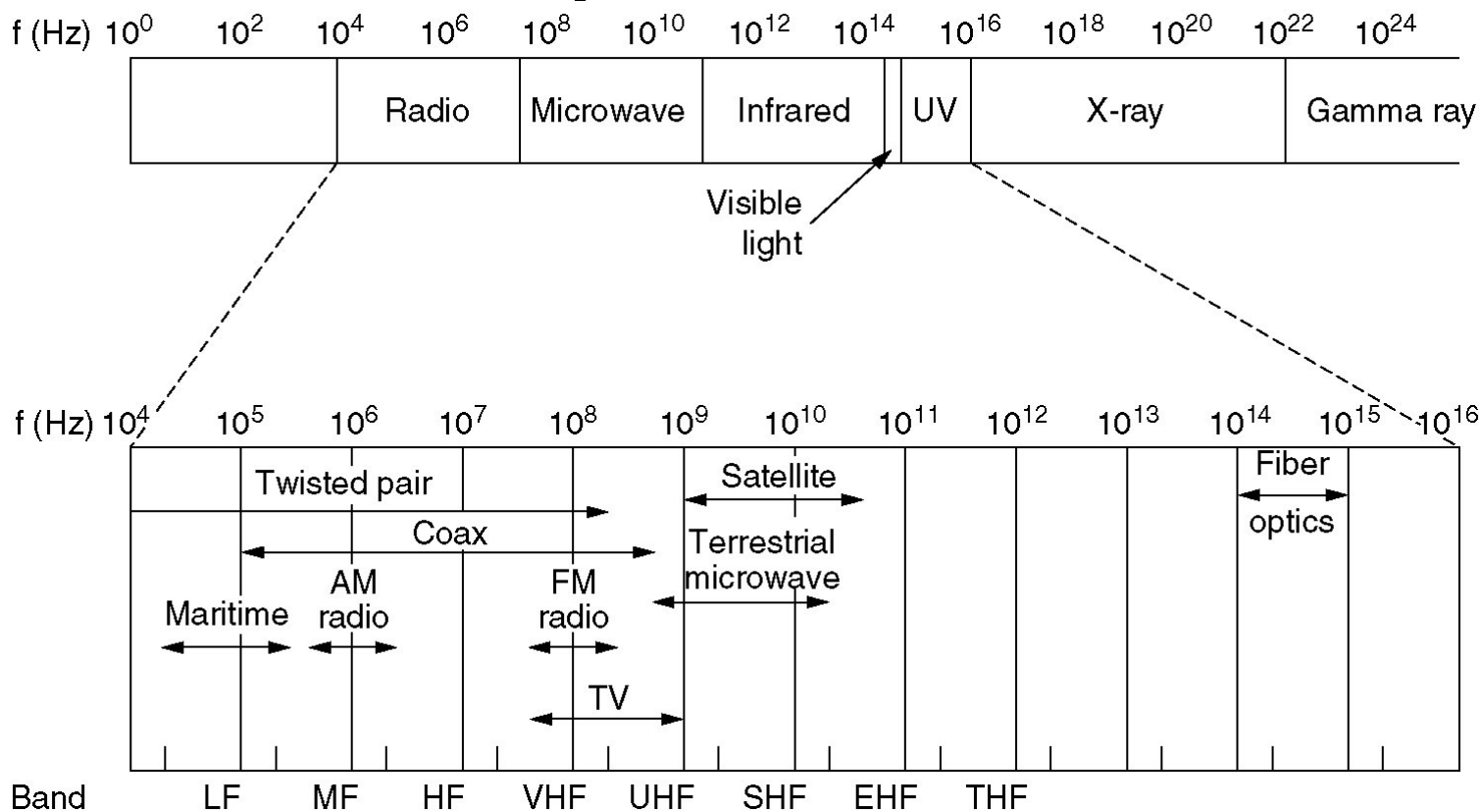

Figure 2-11. The electromagnetic spectrum and its uses for communication.

Wireless LANs

- An application of omni-directional wireless communications to provide high-speed communications among a number of computers located in close proximity.
- In 1996 FCC in US announced its intentions to make 350 MHz of spectrum in the 5.15 to 5.35 GHz and 5.725 to 5.825 GHz bands available for unlicensed use in LAN applications.