

Computer Graphics

CS 4731 Lecture 25

Polygon Filling & Antialiasing

Prof Emmanuel Agu

*Computer Science Dept.
Worcester Polytechnic Institute (WPI)*

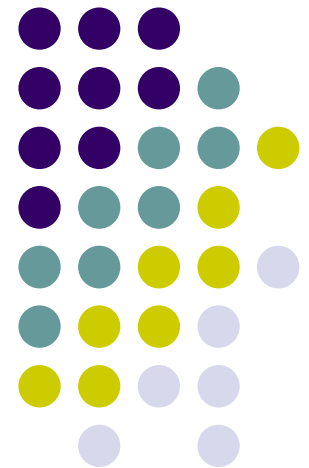

Defining and Filling Regions of Pixels

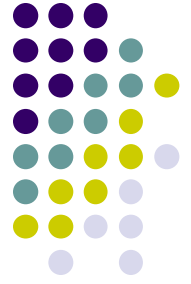

- Methods of defining region
 - **Pixel-defined:** specifies pixels in color or geometric range
 - **Symbolic:** provides property pixels in region must have
 - Examples of symbolic:
 - Closeness to some pixel
 - Within circle of radius R
 - Within a specified polygon

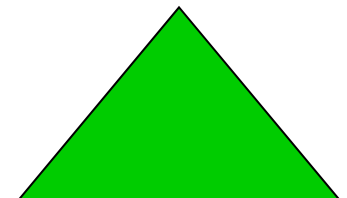
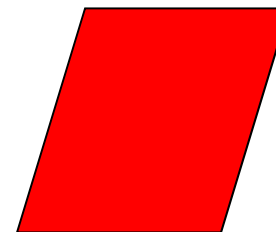



Pixel-Defined Regions

- **Definition:** Region R is the set of all pixels having color C that are connected to a given pixel S
- **4-adjacent:** pixels that lie next to each other horizontally or vertically, NOT diagonally
- **8-adjacent:** pixels that lie next to each other horizontally, vertically OR diagonally
- **4-connected:** if there is unbroken path of 4-adjacent pixels connecting them
- **8-connected:** unbroken path of 8-adjacent pixels connecting them



Recursive Flood-Fill Algorithm

- Recursive algorithm
- Starts from initial pixel of color, **intColor**
- Recursively set 4-connected neighbors to **newColor**
- **Flood-Fill**: floods region with **newColor**
- **Basic idea**:
 - start at “seed” pixel (x, y)
 - If (x, y) has color **intColor**, change it to **newColor**
 - Do same recursively for all 4 neighbors

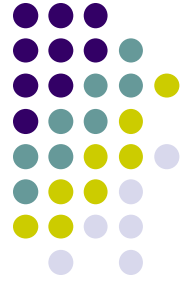

Recursive Flood-Fill Algorithm

- **Note:** `getPixel(x,y)` used to interrogate pixel color at (x, y)

```
void floodFill(short x, short y, short intColor)
{
    if(getPixel(x, y) == intColor)
    {
        setPixel(x, y);
        floodFill(x - 1, y, intColor); // left pixel
        floodFill(x + 1, y, intColor); // right pixel
        floodFill(x, y + 1, intColor); // down pixel
        floodFill(x, y - 1, intColor); // up pixel
    }
}
```

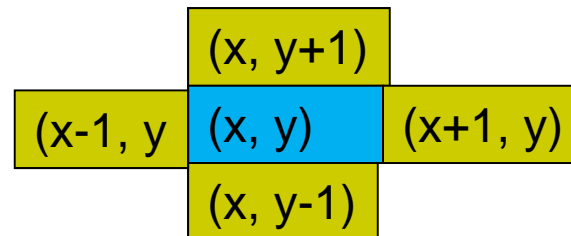



Recursive Flood-Fill Algorithm

- Recursive flood-fill is blind
- Some pixels retested several times
- **Region coherence** is likelihood that an interior pixel mostly likely adjacent to another interior pixel
- **Coherence** can be used to improve algorithm performance
- **A run:** group of adjacent pixels lying on same scanline
- Fill runs(adjacent, on same scan line) of pixels

Region Filling Using Coherence

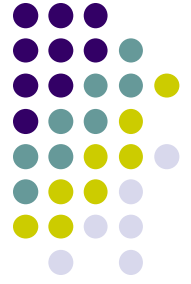

- Example: start at s, initial seed

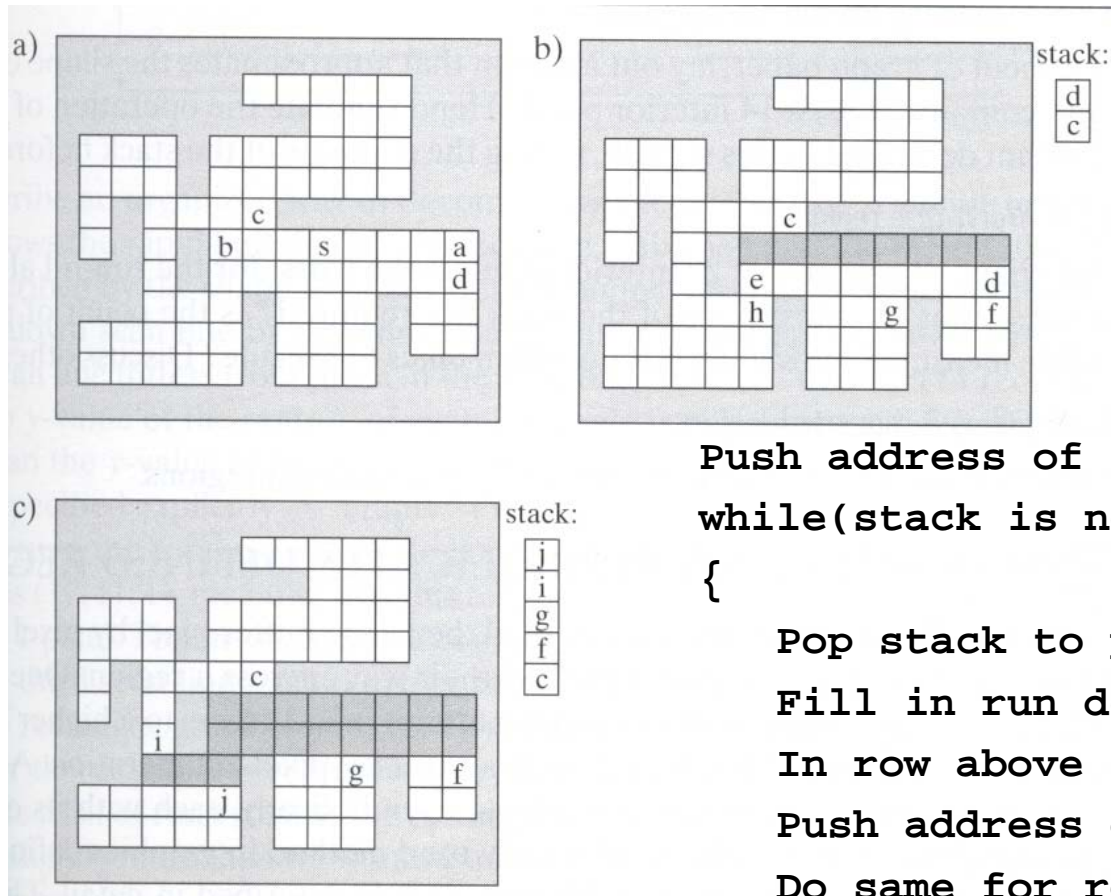

Pseudocode:

```

Push address of seed pixel onto stack
while(stack is not empty)
{
    Pop stack to provide next seed
    Fill in run defined by seed
    In row above find reachable interior runs
    Push address of their rightmost pixels
    Do same for row below current run
}
    
```

Note: algorithm most efficient if there is **span coherence** (pixels on scanline have same value) and **scan-line coherence** (consecutive scanlines similar)



Filling Polygon-Defined Regions

- **Problem:** Region defined polygon with vertices $P_i = (X_i, Y_i)$, for $i = 1 \dots N$, specifying sequence of P 's vertices

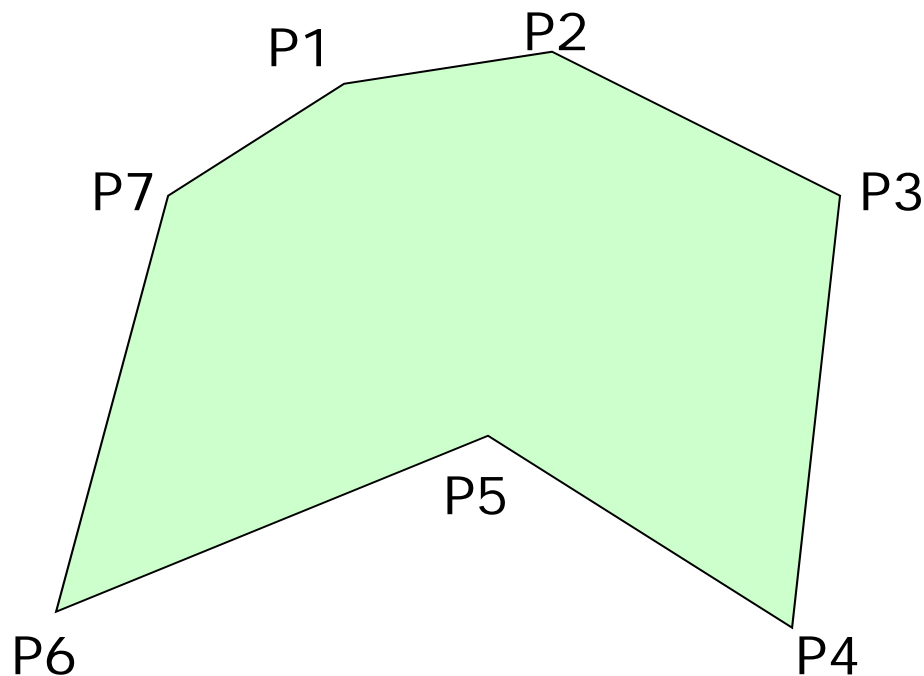

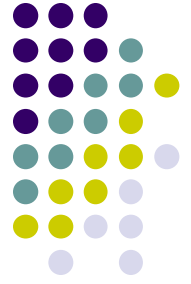

Filling Polygon-Defined Regions

- **Solution:** Progress through frame buffer scan line by scan line, filling in appropriate portions of each line
- Filled portions defined by intersection of scan line and polygon edges
- Runs lying between edges inside P are filled
- **Pseudocode:**

```
for(each scan Line L)
{
    Find intersections of L with all edges of P
    Sort the intersections by increasing x-value
    Fill pixel runs between all pairs of intersections
}
```

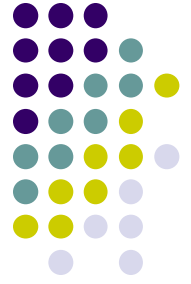

Filling Polygon-Defined Regions

- **Example:** scan line $y = 3$ intersects 4 edges $e3$, $e4$, $e5$, $e6$
- Sort x values of intersections and fill runs in pairs
- **Note:** at each intersection, inside-outside (parity), or vice versa

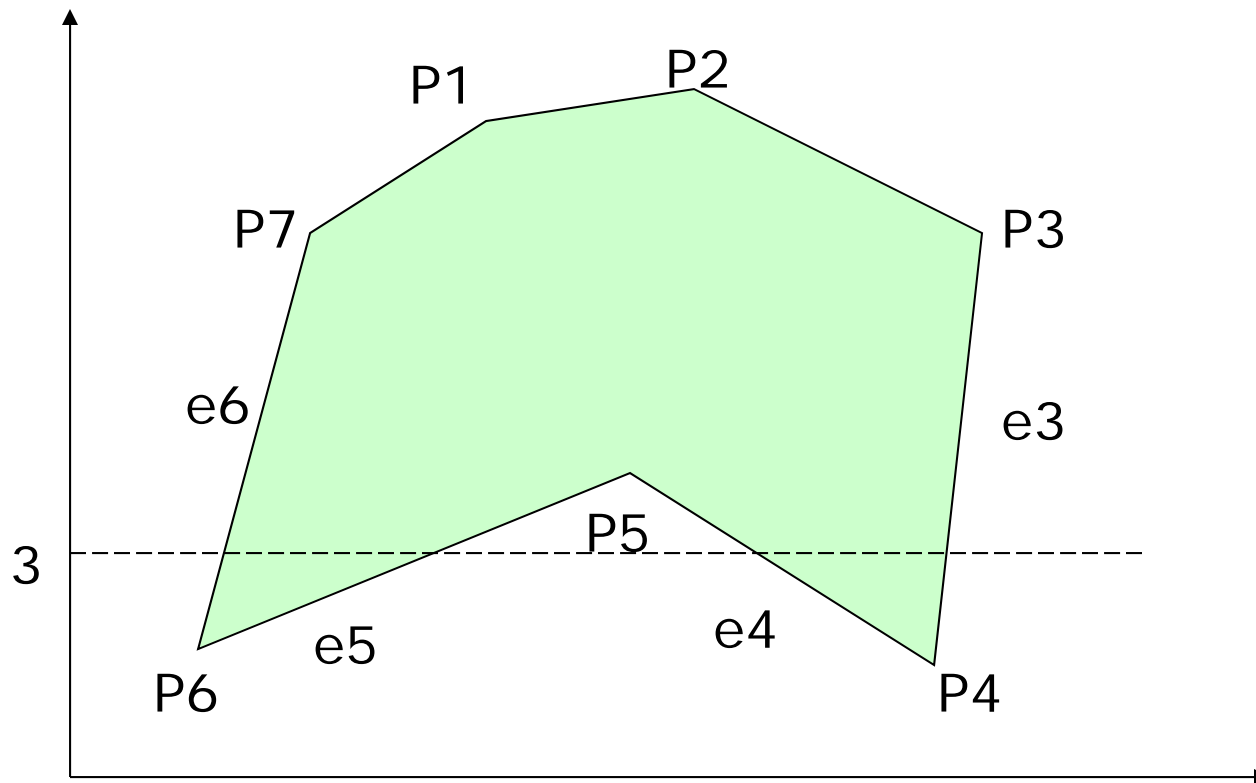

Data Structure

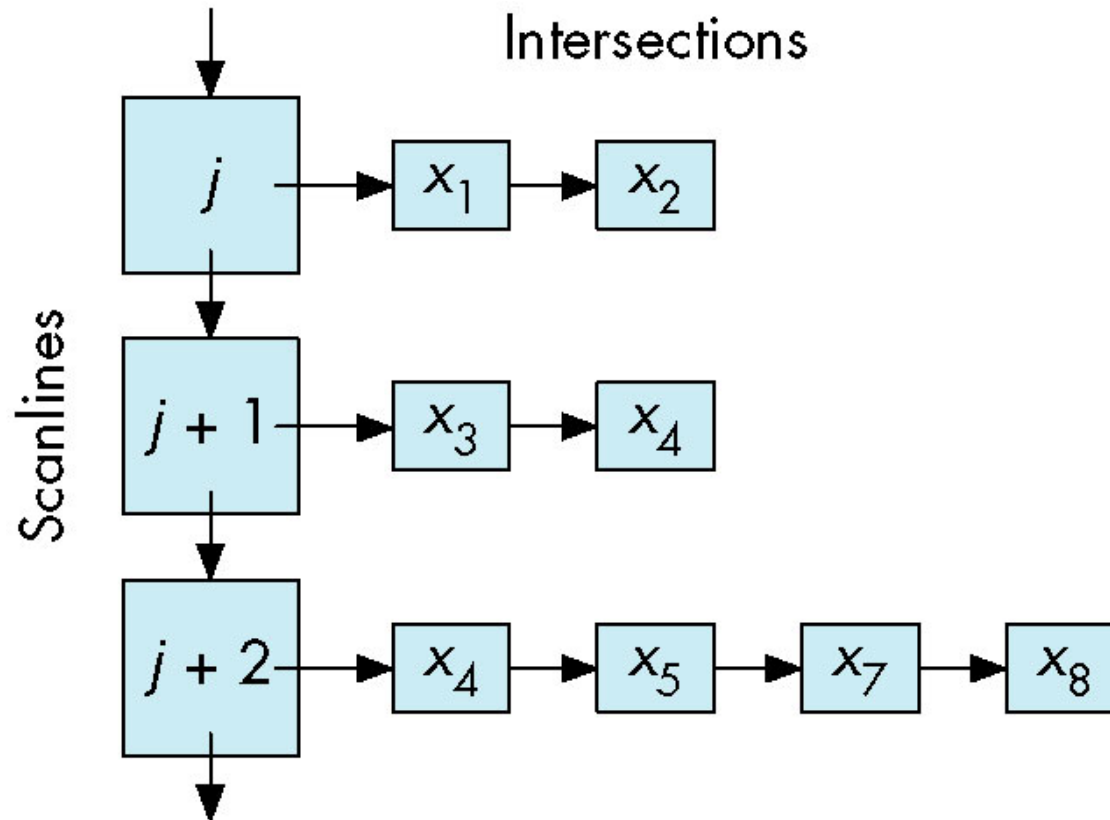



Filling Polygon-Defined Regions

- **Problem:** What if two polygons A, B share an edge?
- Algorithm behavior could result in:
 - setting edge first in one color and the another
 - Drawing edge twice too bright
- **Make Rule:** when two polygons share edge, each polygon owns its **left** and **bottom** edges
- E.g. below draw shared edge with color of polygon **B**

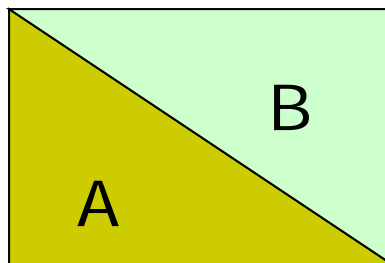

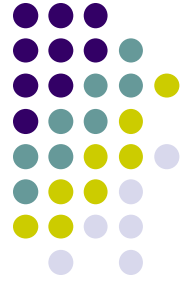

Filling Polygon-Defined Regions

- **Problem:** How to handle cases where scan line intersects with polygon endpoints to avoid wrong parity?
- **Solution:** Discard intersections with horizontal edges and with upper endpoint of any edge

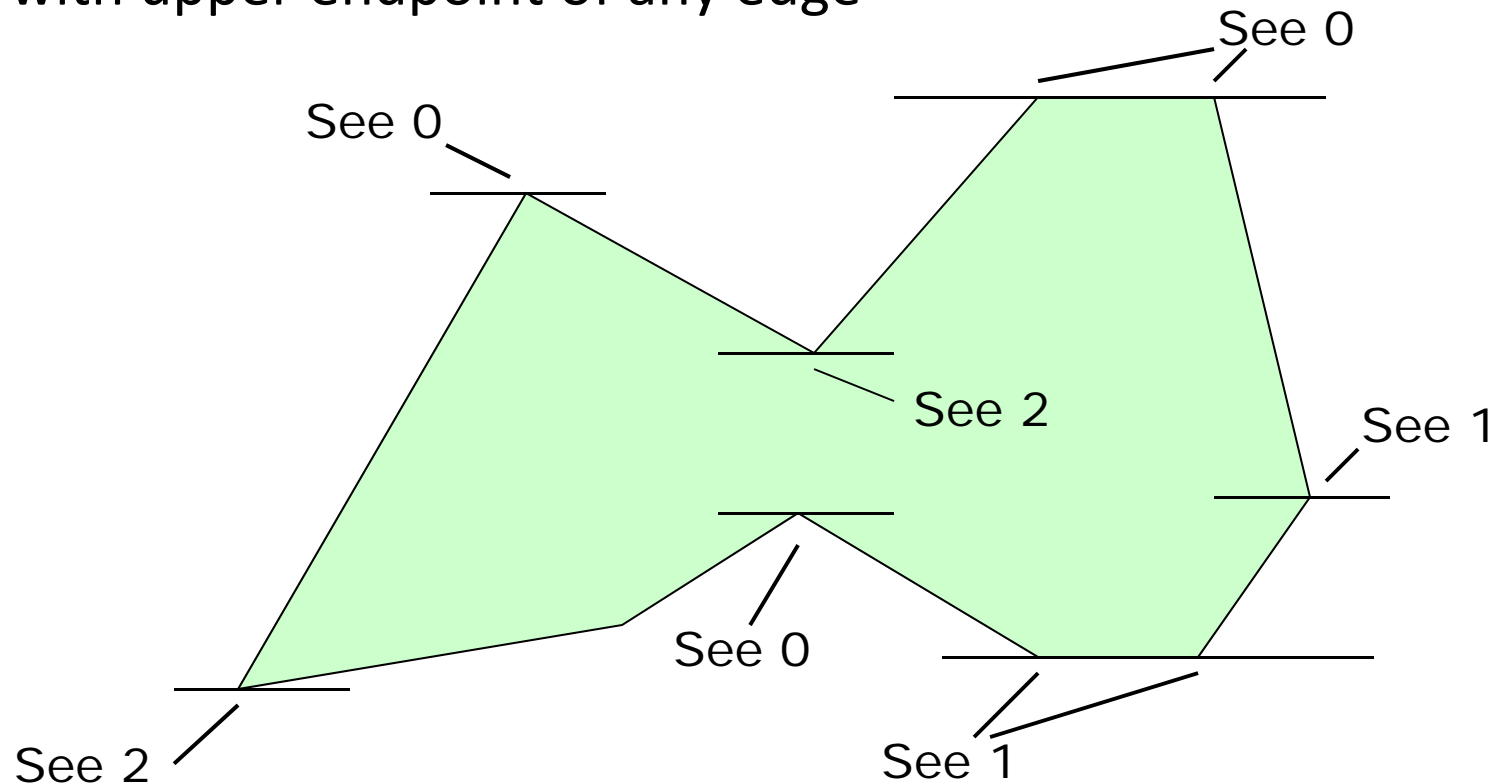



Antialiasing

- Raster displays have pixels as rectangles
- Aliasing: Discrete nature of pixels introduces “jaggies”

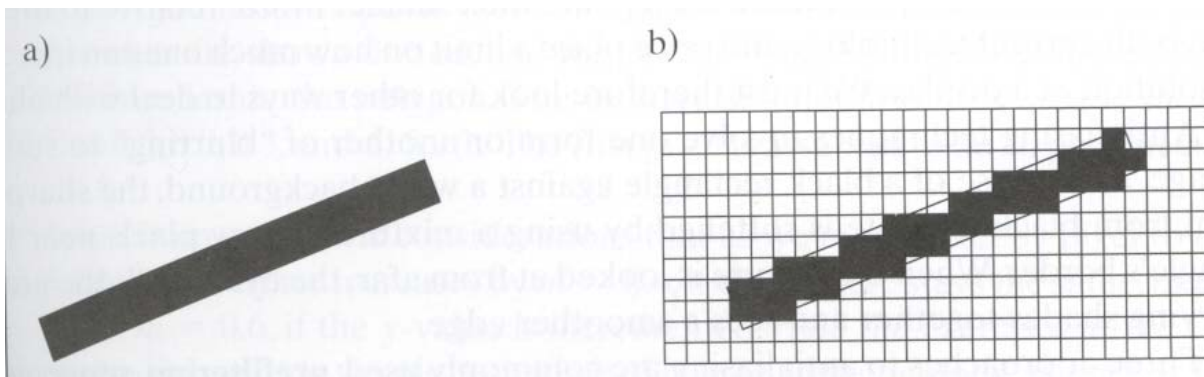



Antialiasing

- Aliasing effects:
 - Distant objects may disappear entirely
 - Objects can blink on and off in animations
- Antialiasing techniques involve some form of blurring to reduce contrast, smoothen image
- Three antialiasing techniques:
 - Prefiltering
 - Postfiltering
 - Supersampling



Prefiltering

- Basic idea:
 - compute area of polygon coverage
 - use proportional intensity value
- Example: if polygon covers $\frac{1}{4}$ of the pixel
 - Pixel color = $\frac{1}{4}$ polygon color + $\frac{3}{4}$ adjacent region color
- Cons: computing polygon coverage can be time consuming

Supersampling



- Assumes we can compute color of any location (x,y) on screen
- Increase frequency of sampling
- Instead of (x,y) samples in increments of 1
- Sample (x,y) in fractional (e.g. $\frac{1}{2}$) increments, average samples
- Example: Double sampling = increments of $\frac{1}{2}$ = 9 color values averaged for each pixel

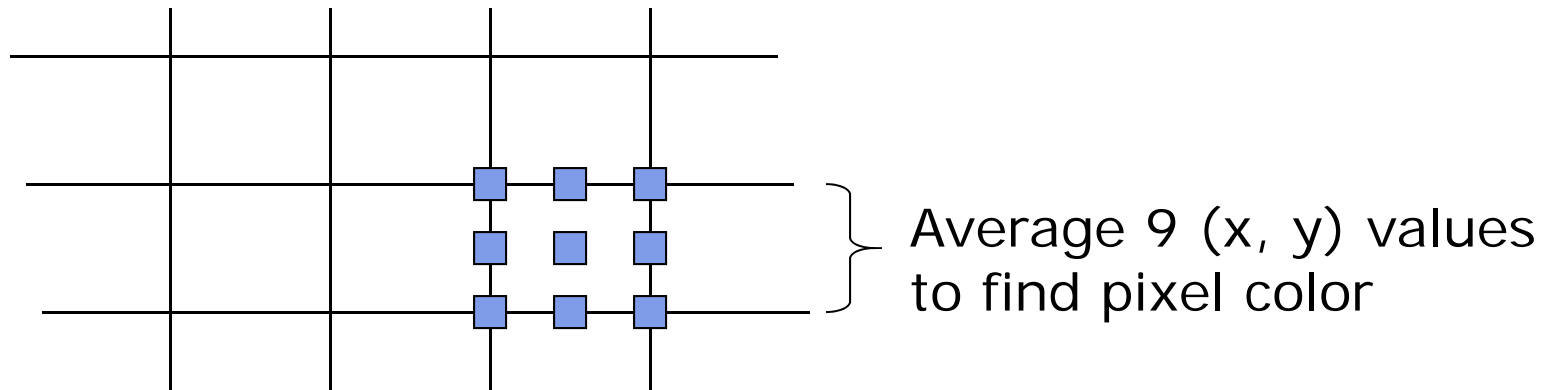

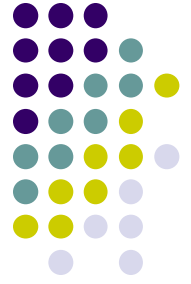

Postfiltering

- Supersampling uses average
- Gives all samples equal importance
- Post-filtering: use weighting (different levels of importance)
- Compute pixel value as weighted average
- Samples close to pixel center given more weight

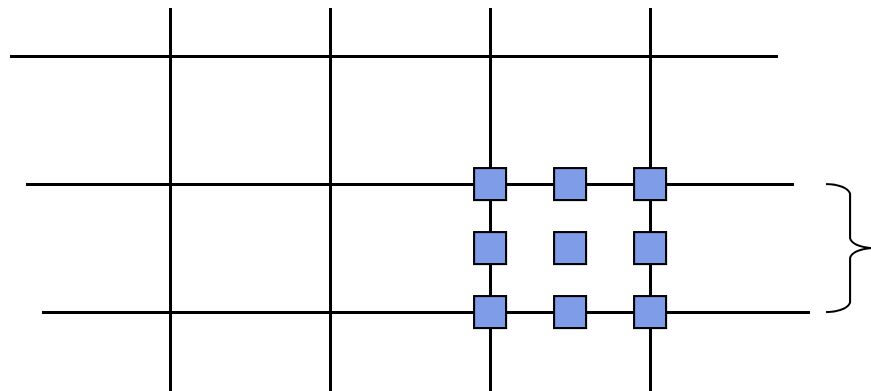

Sample weighting

$1/16$	$1/16$	$1/16$
$1/16$	$1/2$	$1/16$
$1/16$	$1/16$	$1/16$



Antialiasing in OpenGL

- Many alternatives
- Simplest: accumulation buffer
- **Accumulation buffer:** extra storage, similar to frame buffer
- Samples are accumulated
- When all slightly perturbed samples are done, copy results to frame buffer and draw



Antialiasing in OpenGL

- First initialize:
 - `glutInitDisplayMode(GLUT_SINGLE | GLUT_RGB | GLUT_ACCUM | GLUT_DEPTH);`
- Zero out accumulation buffer
 - `glClear(GLUT_ACCUM_BUFFER_BIT);`
- Add samples to accumulation buffer using
 - `glAccum()`

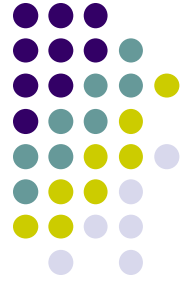

Antialiasing in OpenGL

- Sample code
- jitter[] stores randomized slight displacements of camera,
- factor, f controls amount of overall sliding

```
glClear(GL_ACCUM_BUFFER_BIT);
for(int i=0;i < 8; i++)
{
    cam.slide(f*jitter[i], f*jitter[i].y, 0);
    display( );
    glAccum(GL_ACCUM, 1/8.0);
}
glAccum(GL_RETURN, 1.0);
```

```
jitter.h
-0.3348, 0.4353
0.2864, -0.3934
.....
```

References

- Hill and Kelley, chapter 11
- Angel and Shreiner, Interactive Computer Graphics, 6th edition

